

Husqvarna



50, 50 Special, 51, and 55

Workshop Manual



Introduction

This workshop manual is mainly intended for Husqvarna 50, 50 Special, 51, and 55 models, but certain chapters can also be used for other models. The manual gives information about how to repair the saw and how to use special tools. In order to make sure that the saw will function properly, always use Husqvarna original spare parts and accessories.

The information, specifications and illustrations in this manual are based on the information in effect at time of printing. Any improvements or changes on these models will be included in future manual revisions.



Table of Contents

| | Page |
|---|-----------|
| 1 Technical Specifications _____ | 2 |
| 2 Service Data _____ | 3 |
| 3 Service Tools _____ | 3 |
| 4 Safety Equipment _____ | 4 |
| 5 Rewind Starter _____ | 12 |
| 6 Ignition System _____ | 15 |
| 7 Centrifugal Clutch _____ | 22 |
| 8 Lubrication System, Oil Pump _____ | 26 |
| 9 Anti-Vibration System _____ | 30 |
| 10 Fuel System _____ | 32 |
| 11 Exhaust System _____ | 47 |
| 12 Cylinder & Piston _____ | 46 |
| 13 Crankcase & Crankshaft _____ | 51 |

1

Technical Specifications

| MODEL | 50 | 50 Special | 51 | 55 |
|--|-----------------|-----------------|-------------|-------------|
| Engine | | | | |
| Displacement - cc (cu. in.) | 49 (3.0) | 51 (3.1) | 51 (3.1) | 53 (3.2) |
| Bore - mm (in.) | 44(1 .73) | 45(1 .77) | 45(1 .77) | 46(1 .81) |
| Stroke - mm (in.) | 32(1 .26) | 32(1 .26) | 32(1 .26) | 32(1 .26) |
| Max. power of speed - rpm | 8400 | 8400 | 9000 | 9000 |
| Idling speed - rpm | 2500 | 2500 | 2500 | 2500 |
| Clutch engagement speed - rpm | 3700 | 3700 | 3700 | 3700 |
| No load free speed - rpm | 12500 | 12500 | 12500 | 12500 |
| Ignition system - Electroixux | ET | ET | ET | ET |
| Air gap - mm (in.) | 0.3 (0.012) | 0.3 (0.012) | 0.3 (0.012) | 0.3 (0.012) |
| Spark plug - Champion | RCJ7Y | RCJ7Y | RCJ7Y | RCJ7Y |
| NGK | BPMR6A | BPMR6A | BPMR6A | BPMR6A |
| Electrode gap - mm (in.) | 0.5 (0.020) | 0.5 (0.020) | 0.5 (0.020) | 0.5 (0.020) |
| Fuel and Lubrication System | | | | |
| Carburetor - Walbro | WA82 | WA82 | WT170 | WTI 70 |
| Fuel tank volume - litre (pint) | 0.6 (1 .27) | 0.6 (1 .27) | 0.6 (1 .27) | 0.6 (1 .27) |
| Oil tank volume - litre (pint) | 0.3 (0.63) | 0.3 (0.63) | 0.3 (0.63) | 0.3 (0.63) |
| Oil pump capacity at 6000 rpm cc/rein. | 7.0 | 7.0 | 7.0 | 7.0 |
| Oil pump type | Automatic | Automatic | Automatic | Automatic |
| Bar and Chain | | | | |
| Bar length | | | | |
| cm | 37-45 | 37-45 | 37-49 | 37-49 |
| inch | 15-18 | 15-18 | 15-20 | 15-20 |
| Chain pitch | .325 | .325 | .325 or 3/8 | .325 or 3/8 |
| Chain speed | | | | |
| .325 m/see | 17.4/7t **** | 17.4/7t **** | 17.4/7t | 17.4/7t |
| 3/8 m/see. | | | 20.2/7t | 20.2/7t |
| Drive link gauge - mm (in.) | 1.5 (0.058) | 1.5 (0.058) | 1.5 (0.058) | 1.5 (0.058) |
| Weight - kg (lbs) | 5.2 (1 1.5) | 5.2 (1 1.5) | 5.2 (1 1.2) | 5.2 (1 1.2) |
| Weight with 38 cm (15 in.) guide bar and chain - kg (lbs) | 6.2 (13.7) | 6.2 (13.7) | 6.2 (13.7) | 6.2 (1 3.7) |

Service Data & Service Tools

2 & 3

Service Data

Leakage Test

Crankcase/cylinder

Recommended pressure: 30 kPa (0.3 kp/cm²) (4 psi)

Maximum leakage: 20 kPa/30 sec. (0.2 kp/cm²)
(3 psi/30 sec)

Service tools for test:

| | |
|------------|--------------------------------------|
| 5025038-01 | Pressure gauge |
| 5049029-02 | Intake/exhaust cover plate, 2 pieces |
| 5025046-01 | Sleeves, 2 pieces |
| 5025403-01 | Sleeves, 2 pieces |

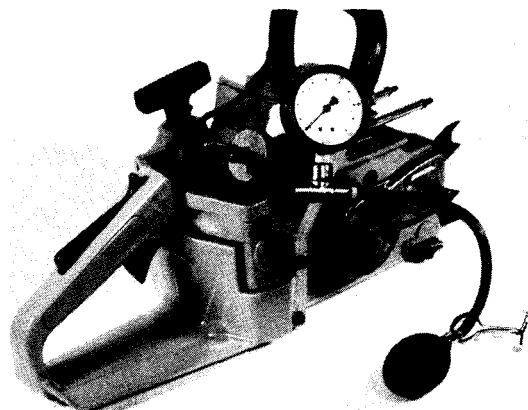

Leakage Test

Carburetor

Recommended pressure: 50 kPa (0.5 kp/cm²) (7.2 psi)

Maximum leakage: No leakage permitted

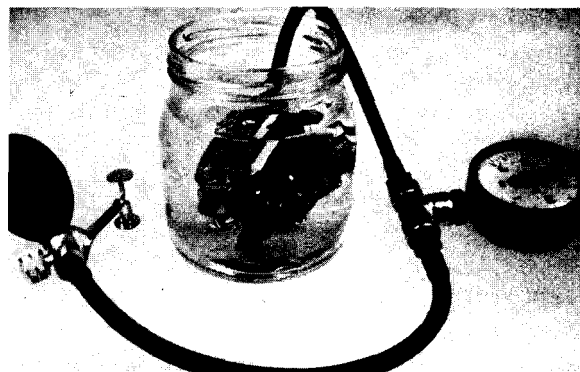

Service Tools

| | |
|------------|--|
| 5025006-01 | Assembling pliers, spark plug |
| 5025018-01 | Allen key, 4 mm |
| 5025019-01 | Allen key, 3 mm |
| 5025022-01 | Socket spanner, 8 mm |
| 5025026-01 | Puller, complete |
| 5025030-09 | Crankshaft installation device, Model 50 serial # 9250857 and up |
| 5025030-12 | Crankshaft installation device |
| 5025033-01 | Piston Stop |
| 5025038-01 | Pressure gauge |
| 5025046-01 | Sleeves, 2 pieces |
| 5025070-01 | Piston mounting set |
| 5025079-01 | Crankshaft seal installation tool |
| 5025083-01 | Hook for fuel filter |
| 5025087-01 | Allen screwdriver with ball |
| 5025099-01 | Worm wheel puller |
| 5025134-02 | Air gap gauge, ignition |
| 5025161-01 | Crankshaft removal tool |
| 5025191-01 | Air gap gauge, spark plug |
| 5025194-01 | Flywheel removal tool |
| 5027113-01 | Test plug |
| 5027114-01 | Tachometer |
| 5049029-02 | Intake/exhaust cover plates, 2 pieces |
| 5049090-01 | Puller, ball bearing |
| 5052679-12 | Flywheel removal tool, Model 50 serial # 9250857 and up |

4

Safety Equipment

The chain brake system has a strong spring under tension. This spring activates the chain brake band when the chain brake is engaged. The spring is located under a cover plate that must be removed during servicing. Anytime the cover is removed and the spring is still under tension it may dislodge without warning. Eye protection must be worn during disassembly and reassembly of the chain brake.

Chain Brake Disassembly

Disengage chain brake. Remove clutch cover retaining nuts and withdraw cover from the chain saw.

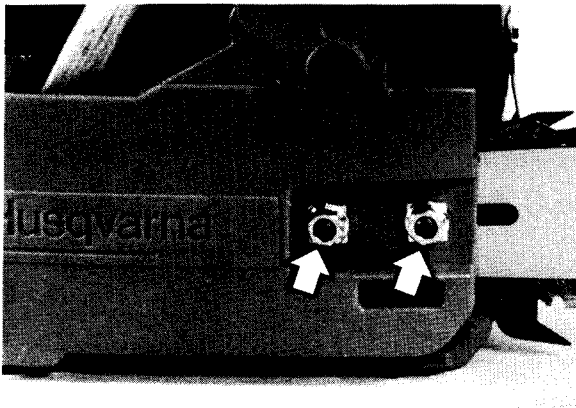

Clean chain brake and clutch cover assembly. Engage the chain brake by moving the hand guard forward.

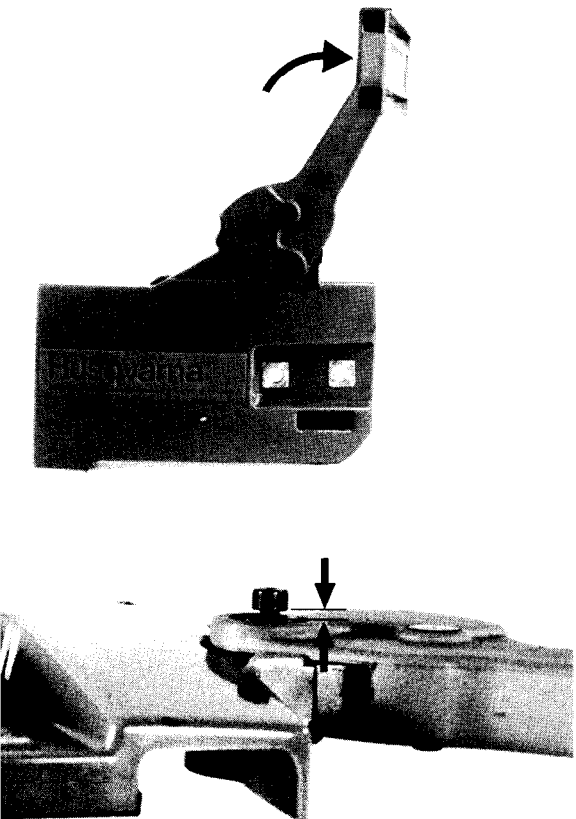

Remove hand guard retaining screw. Rethread screw into pivot sleeve two turns. Press on screw head to drive out pivot sleeve half on the opposite side.

4

Turn cover over. Using a suitable punch, drive out remaining half of pivot sleeve. Separate hand guard from cover.

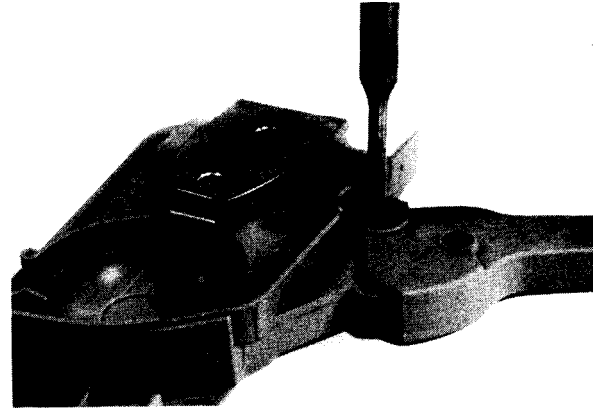

Remove the five screws and lift off the cover plate.

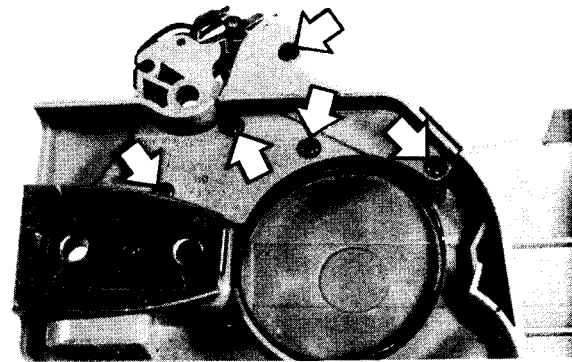

CAUTION !

**The spring is under tension.
Always wear safety goggles for eye protection.**

Using the tip of a flat bladed screwdriver, carefully lift the end of spring out of the cover.

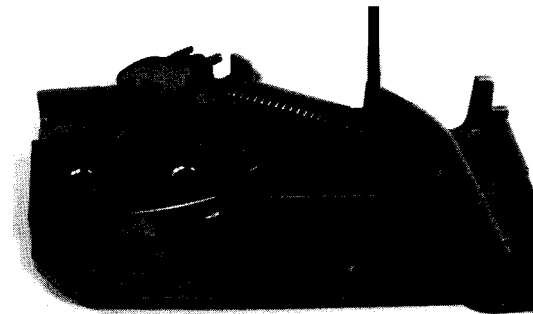

Press out the pin which holds the linkage arm using a suitable punch.

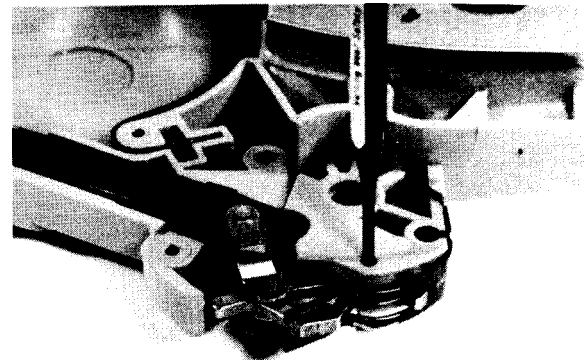

5

4

Turn the cover over and press out the brake bank retaining pin with a punch.

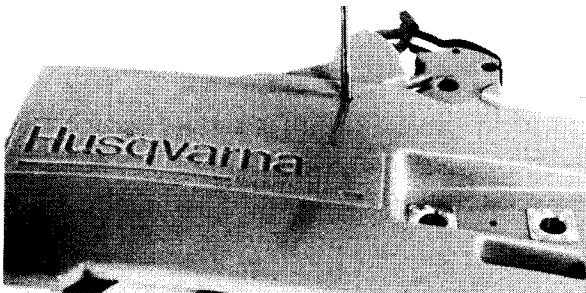

Check the brake band for wear. Measure the thickness of the band. The original thickness of the brake band is 0.80 mm (0.031 in.). The brake band must be exchanged if the band is worn anywhere along its length to 0.65 mm (0.026 in.) or less.

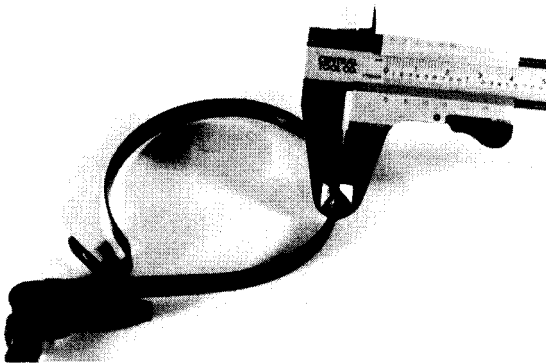

If the brake band needs to be exchanged, separate the band from the linkage by removing the screw.

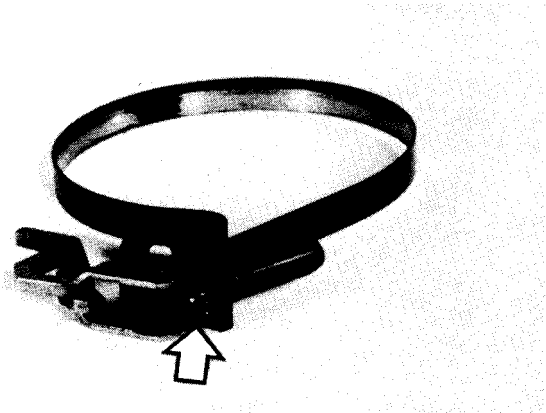

Assembly

Check all chain brake parts for wear or damage and replace with new parts if necessary. Lubricate the linkage and pivots with thin oil.

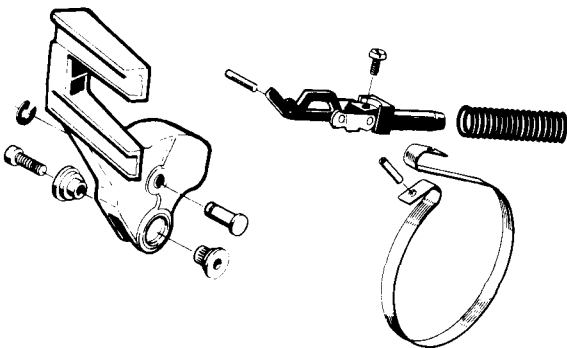

4

Assemble the brake band and knee link. Insert the roll pin into the brake band so the open side of the pin is up as shown in photo.

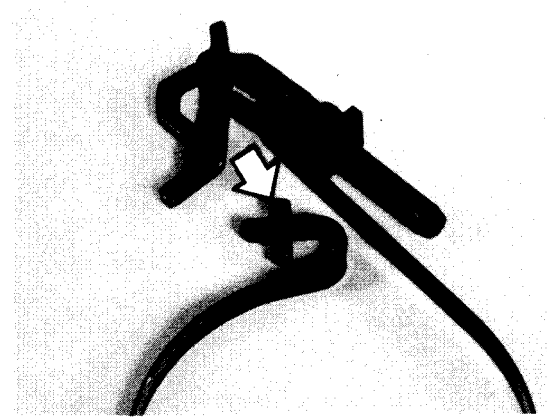

Insert the linkage and band assembly into the cover. Secure the knee link to the cover with the retaining pin. Slide the brake spring over the linkage spring post.

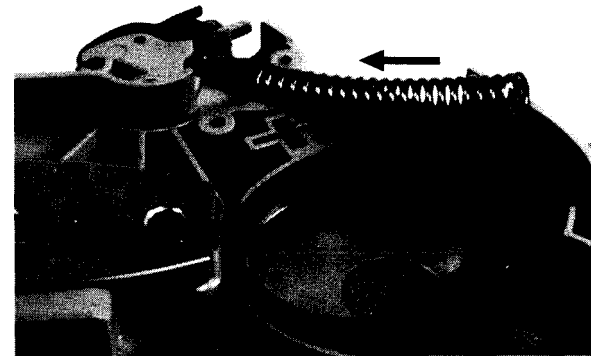

Using a flat bladed screwdriver, depress the spring, then carefully press the spring end into the cover.

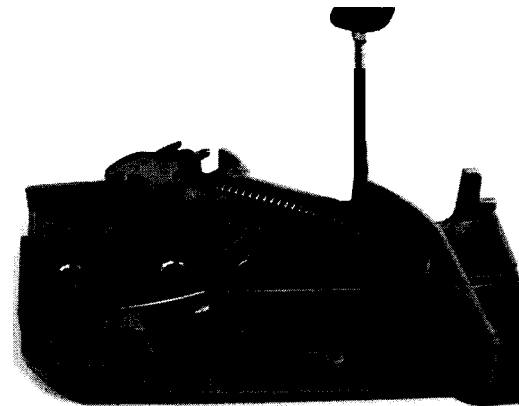

Install the cover plate.

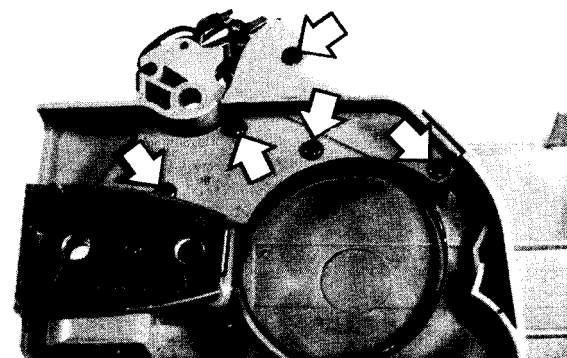

4

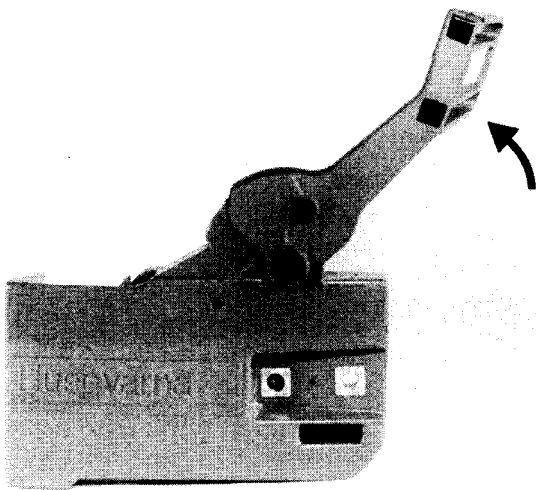

Press the front hand guard into position. Install the pivot sleeves and screw. Pull the hand guard back to disengage the brake.

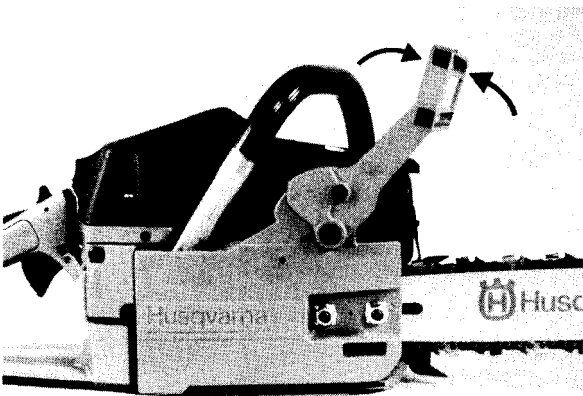

Mount the bar, chain and chain brake to the saw. Before running the saw, check the brake function by moving the hand guard forward until the brake engages. With the brake engaged, it should not be possible to rotate the saw chain around the guide bar. Pull the hand guard back towards the front handle to disengage the brake.

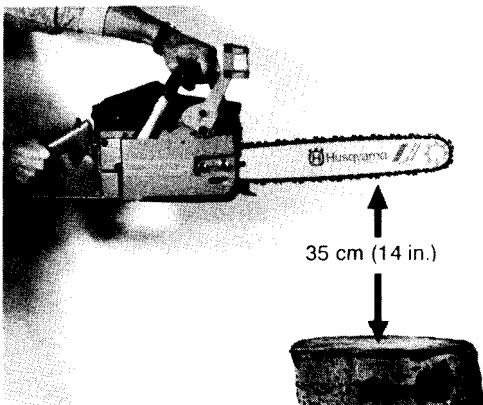

Inertia Chain Brake Function

WARNING !

The engine must be stopped for the following test.

With the engine stopped, hold the chain saw with both hands. With the chain saw horizontal, position the bar tip approx. 35 cm (14 in.) above a tree stump or other firm object such as a solid wood table.

4

While holding onto the rear handle, release your grip around the front handle. The chain saw will swing downward allowing the bar tip to contact the tree stump. When the tip of the bar contacts the stump, the chain brake should activate.

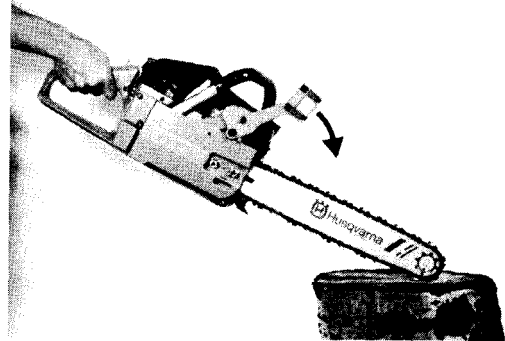

Manual Chain Brake Function

Place the saw on firm ground and start the engine. Hold the handles with both hands and apply full throttle. Activate the chain brake by turning your left wrist against the hand guard. The saw chain should stop moving immediately.

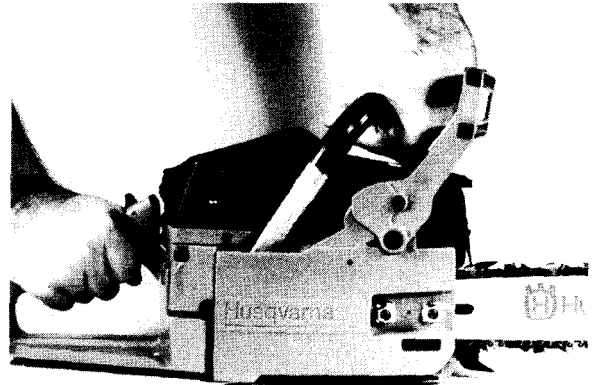

Throttle Trigger Lockout Disassembly

Press out the pin.

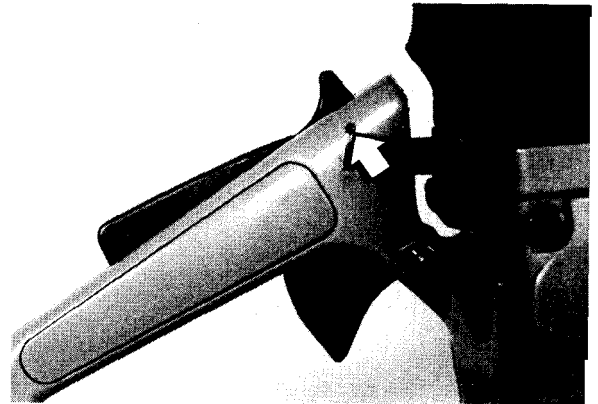

On the 50 and 50 Special models, the throttle lockout lever has a small tab midway on the left side. Insert a small screwdriver between the lever and lever opening on the left side so that the tab will clear the handle then withdraw the lever out through the top.

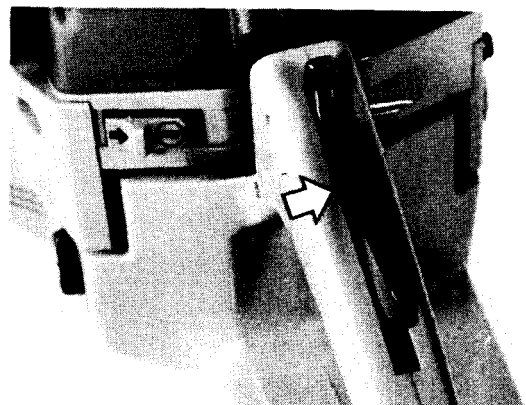

4

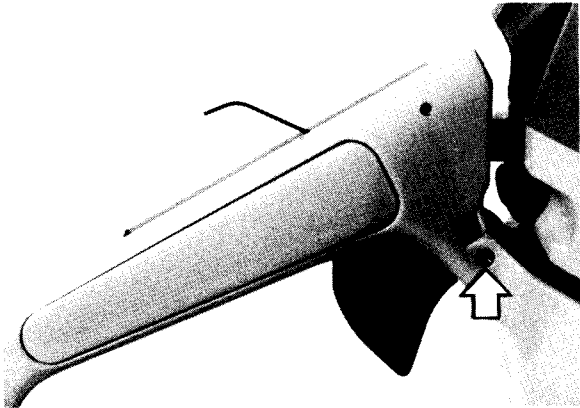

Drive out the pin for the throttle trigger. Raise the throttle trigger up into the handle and unhook the spring.

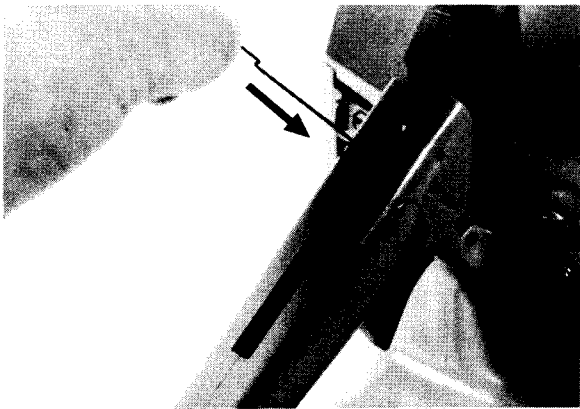

Assembly

Insert the spring down through the recess in the handle. Hook the spring onto throttle trigger.

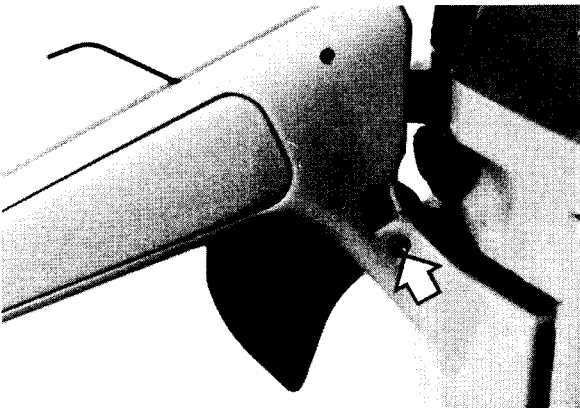

Align the pin hole in the trigger with the corresponding hole in the handle and install the pin.

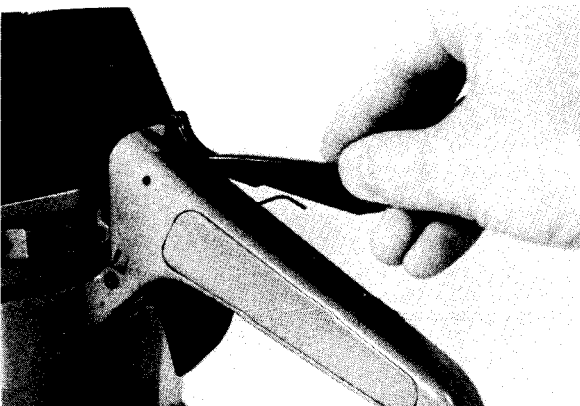

Insert the lockout lever making sure the end of the spring fits within the lever.

4

Align the pin holes and drive in the pin. After assembly check throttle lockout function. It should not be possible to move the throttle trigger (accelerate the saw) without first depressing the lockout lever.

NOTE !

On 51 and 55 models, the fast idle system is integrated into the choke system. When the choke knob is pulled, the fast idle is engaged for starting purposes. When the throttle trigger is depressed, the fast idle system disengages allowing the engine to return to idle when the trigger is released.

Chain Catcher

Check the chain catcher. If the chain catcher is missing or damaged, install a new catcher.

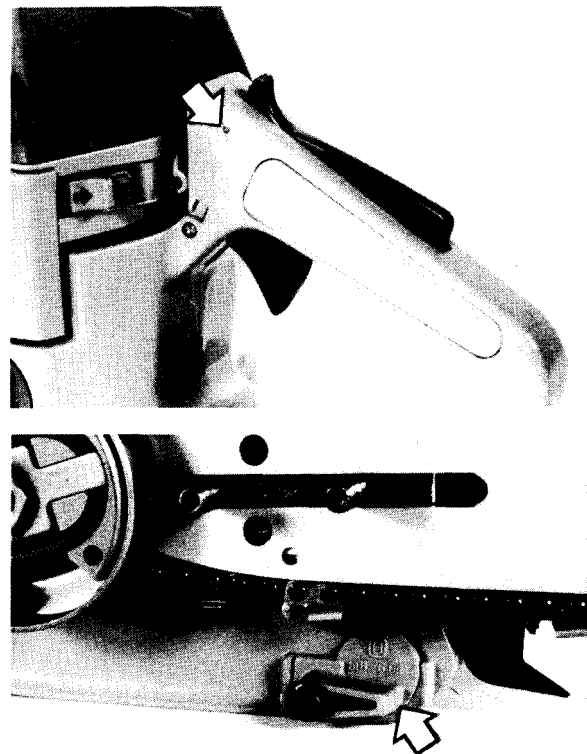

5

Rewind Starter

Disassembly

Remove the four starter housing retaining screws and remove the starter assembly from the crankcase.

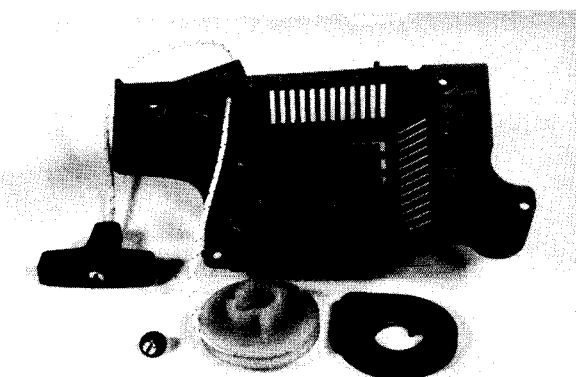
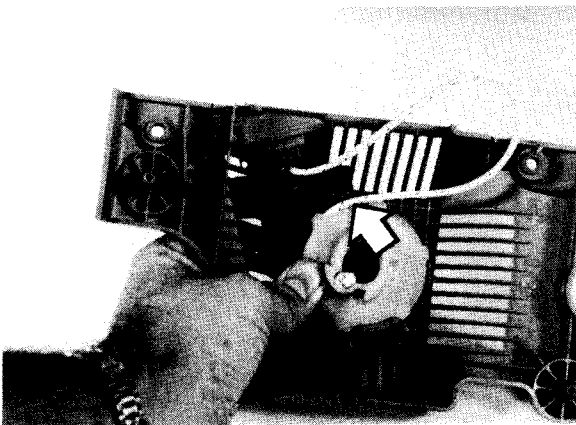
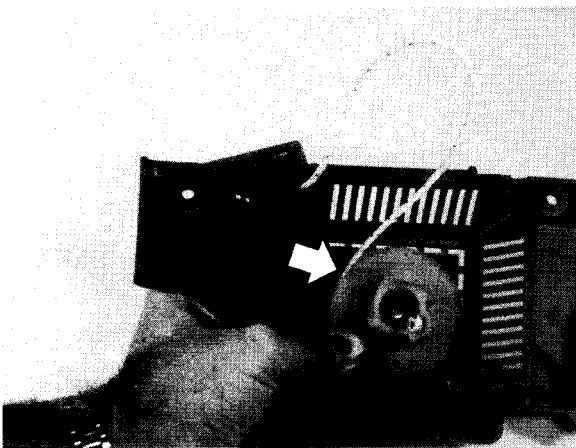

If the starter rope is still under tension from the rewind spring, pull the starter grip out approximately 30 cm (12 inches) and hold starter pulley. Pull a loop of starter rope up between pulley and housing. On 50 and 50 Special models, engage rope in pulley notch. On 51 and 55 models, pull rope up between any notched section in pulley.

Carefully and slowly release the pulley to allow the rewind spring to unwind. Remove pulley retaining screw from the starter post and remove the pulley. Carefully withdraw the recoil spring cassette. Clean all parts before assembly.

WARNING !

Be very careful when removing and installing the rewind spring. The rewind spring can become dislodged from the spring cassette causing injuries. Wear safety goggles for eye protection.

5

Assembly

New starter rope length is 88 cm (34.5 inches). Tie a knot in one end of the rope. Insert the other end through the rope pulley first, then through the rope eyelet in the housing and the starter grip.

Tie the rope at the starter grip end with a double loop knot.

Install the new recoil spring cassette into the housing. Lubricate the starter post with cold-resistant grease.

Wind 3 turns of the starter cord in a clockwise direction onto the pulley. Install the rope pulley, washer and retaining screw.

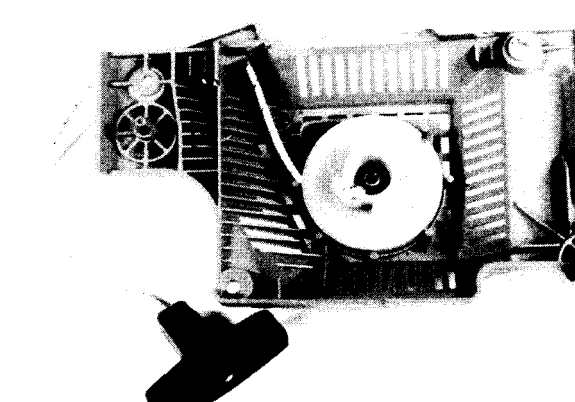
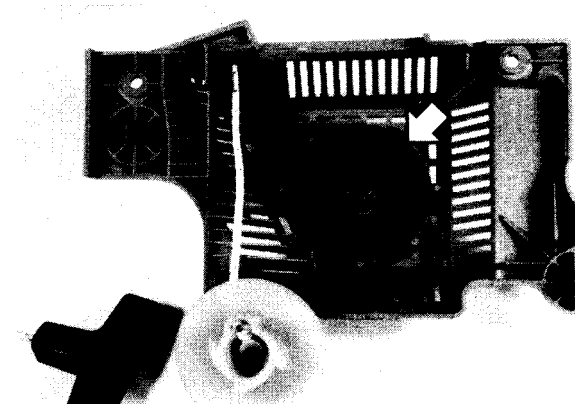
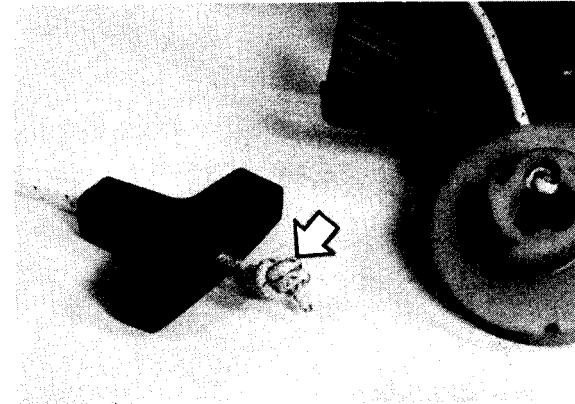
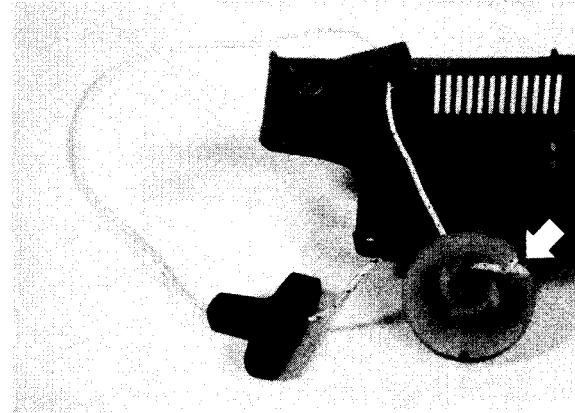

5

Pull the starter cord up into the pulley notch and rotate the pulley clockwise two turns.

NOTE !

Check that the starter pulley can be turned at least one half of a turn further when the starter cord is pulled to the end of rope travel.

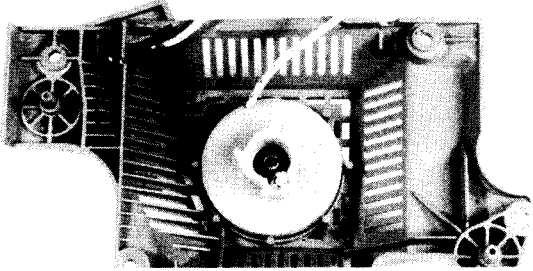

To install the starter assembly on crankcase, first pull the starter grip out approximately 15 cm (6 in.) then position the housing against the crankcase.

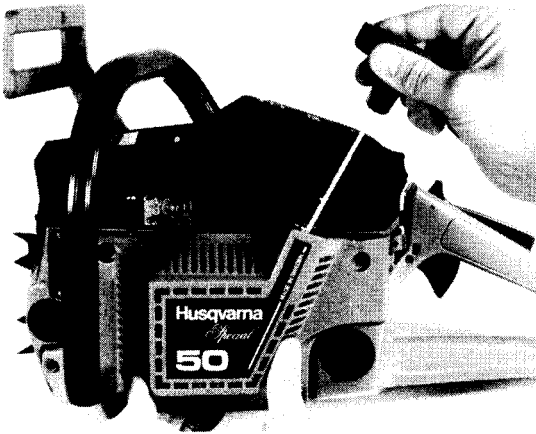

Release the grip so that the pulley engages the starter pawls on the flywheel. Install and tighten the four starter retaining screws.



Ignition System

6

Ignition System

These models are equipped with an electronic ignition system. One of the characteristics of this system is that the spark across the spark plug electrode gap has a higher energy and shorter burning time (arc duration time). When viewing the spark on a properly functioning ignition system, the spark will appear to be weaker compared to breaker point ignition systems due to the shorter arc duration time.

Spark Plug

Champion RCJ7Y and NGK BPMR6A are the only spark plugs that should be used. The spark plug should be removed, cleaned and inspected at least once a week. The spark plug electrode gap should be 0.5 mm (0.020 in.).

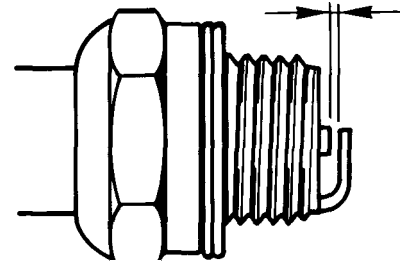

If the electrodes are worn, install a new, properly gapped spark plug.

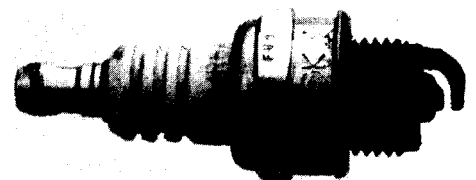

Checking for Spark

Remove the spark plug. Move the ignition stop switch to the "ON" position.

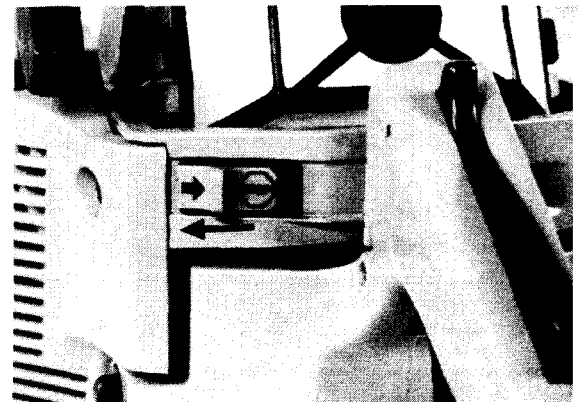

6

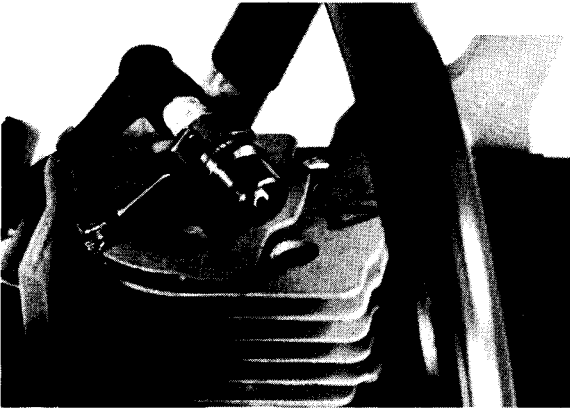

Attach the high tension lead to the spark plug. Ground the spark plug against the cylinder. With the chain saw secure from movement, pull the starter quickly while watching for a spark across the spark plug electrode.

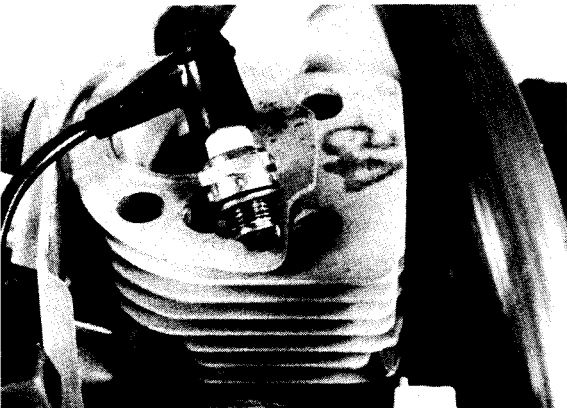

If no spark is evident, retest with a new spark plug or test plug P/N 5027113-01.

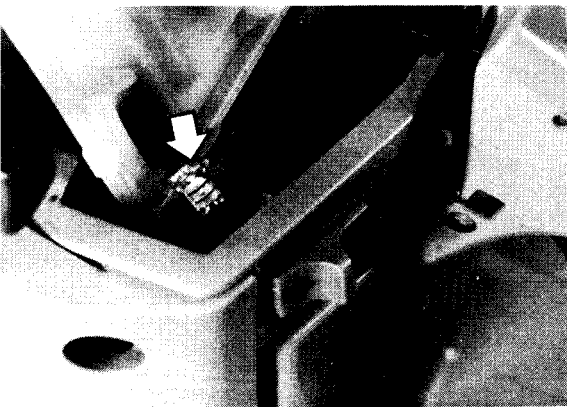

If spark is still absent, disconnect the short circuit wire from the stop switch. Check for spark again as previously described. If spark occurs, the stop switch is defective and should be replaced.

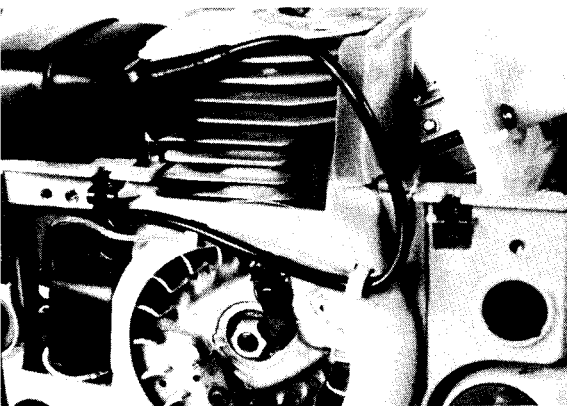

If no spark is evident, carefully inspect the full length of the short circuit wire and the high tension lead to the spark plug. Ensure that short circuit wire isn't pinched or grounded against any metal surface (i.e., crankcase, cylinder). Check the high tension lead connector at the spark plug for a poor connection and the full length of the lead for breakage or damaged insulation.

6

Check the air gap between the ignition module and flywheel magnets. The air gap should be 0.3 mm (0.012 in.). The ignition air gap can be checked using air gap tool 5025134-02.

If the ignition air gap requires adjustment, first loosen the ignition module retaining screws. With the flywheel magnets aligned with the ignition module, insert the air gap tool between the flywheel and module. Hold the ignition module against the flywheel and tighten the module retaining screws. Remove the air gap tool and recheck for spark. If no spark occurs, replace the ignition module.

Ignition Module Removal

Disconnect the high tension lead from the spark plug. Disconnect the short circuit wire at the ignition module. Remove the ignition module retaining screws and withdraw the module from the saw.

Ignition Module Installation

Install the ignition module, but do not tighten the screws. Make sure one of the module screws secures the module ground wire. Place the air gap tool between the module and the flywheel magnets. While holding the module against the flywheel, tighten the module retaining screws. Remove the air gap tool.

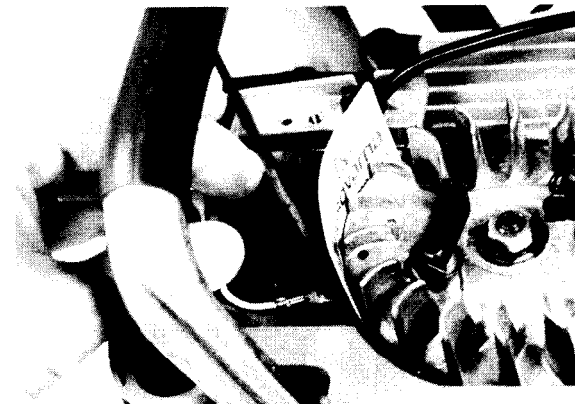
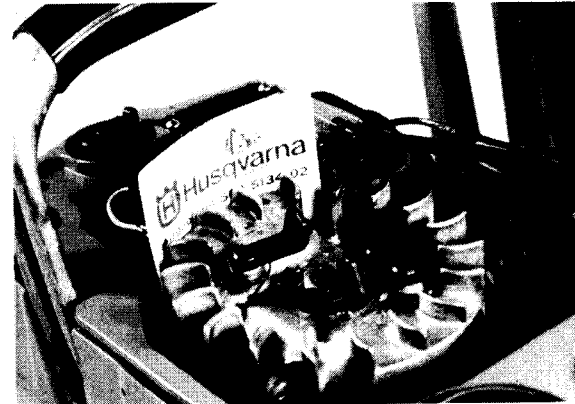

6

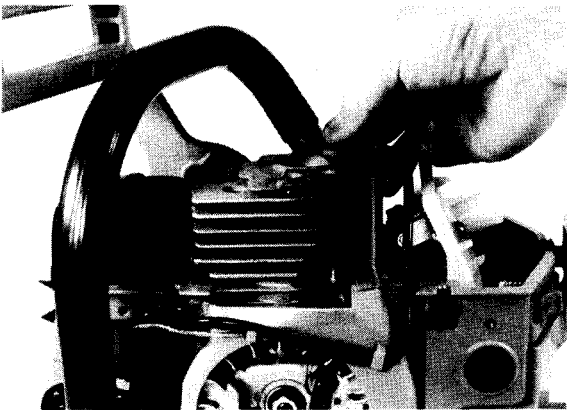

If the ignition module is new, it will be necessary to install a new spark plug connector spring on the high tension lead. Before installing the connector spring, first correctly route the high tension lead from the module to the spark plug. If necessary, cut the high tension lead to the correct length.

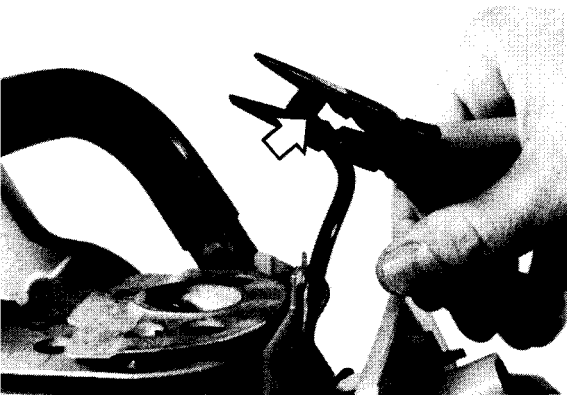

Using the assembly pliers P/N 5025006-01, make a hole for the contact spring approximately 13 mm (1/2 in.) from the end of the lead.

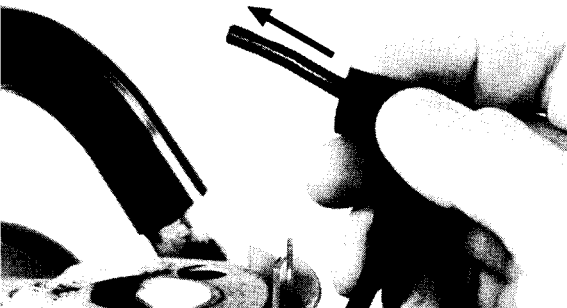

Push the high tension lead through the spark plug boot until the lead extends out the other side.

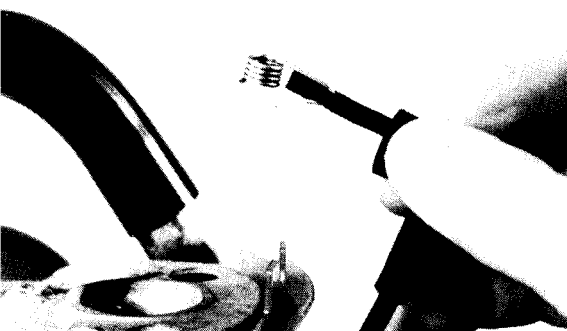

Install the contact spring onto the end of the high tension lead with the assembly pliers.

6

Carefully pull the spark plug boot over the spring. Assemble the starter to the saw and check for spark as previously instructed in the Checking for Spark section.

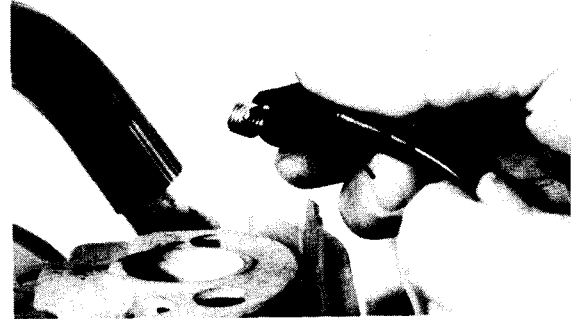

Flywheel Removal

Remove the spark plug and thread the piston stop P/N 5025033-01 into the spark plug opening in the cylinder.

NOTE !

Make sure that the piston stop is threaded completely into the cylinder.

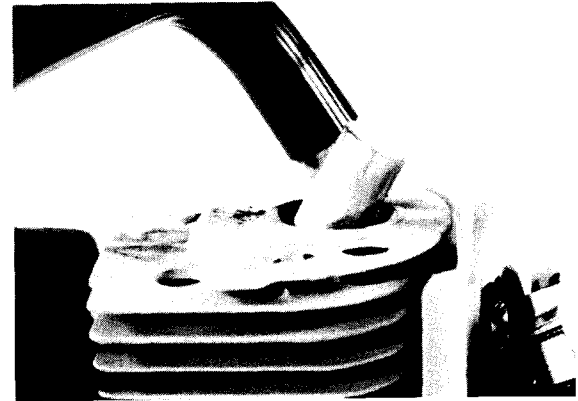

Gently rotate the flywheel counterclockwise by hand until the piston contacts the piston stop. Remove the flywheel retaining nut and washer. The flywheel nut has right-handed threads.



Thread the flywheel remounting device P/N 5052679-12 onto the end of the crankshaft. After the tool contacts the flywheel, unthread the tool 1-1/2 turns so that an approximate clearance of 2 mm (0.078 in.) exists between the tool and the flywheel.



6

Hold onto the flywheel and lift the saw slightly above the work surface. Strike the tool squarely on its end with a hammer to free the flywheel from the crankshaft. Remove the tool and flywheel.

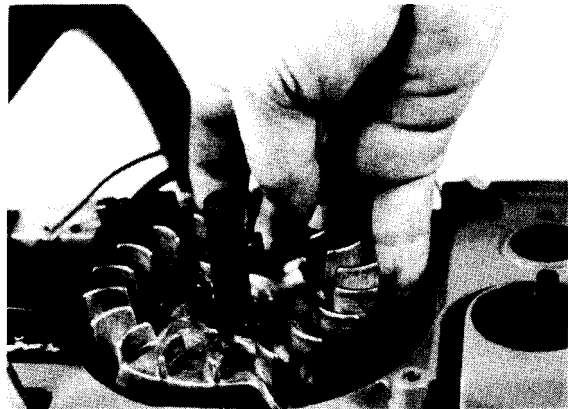

The starter pawls and springs are serviceable. To remove the starter pawls, position the flywheel with the starter pawls down on two pieces of wood so that the pawls are exposed. Drive out the pawl retaining pins with a suitable drift.

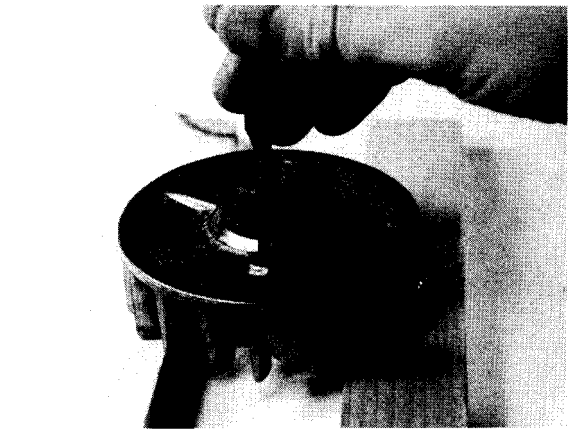

Inspect the starter pawls and springs. Replace components if necessary. Reassemble the pawls and springs in the reverse order of disassembly. Press the pawl retaining pins into the flywheel. Make sure that the shoulder on the pins are flush against the flywheel surface and that the pawls pivot freely.

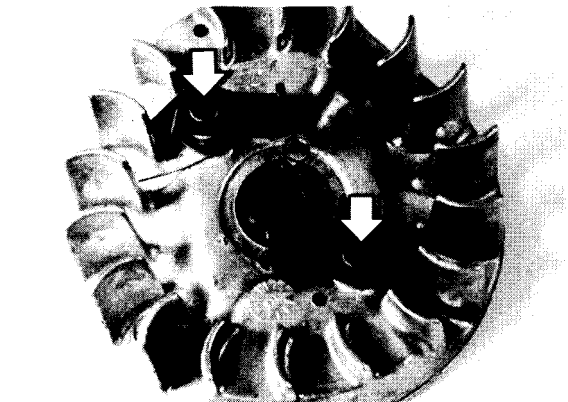

Flywheel Installation

Thoroughly clean and dry the flywheel bore and the corresponding taper on the crankshaft. On models equipped with a removable flywheel key, replace the key if damaged.

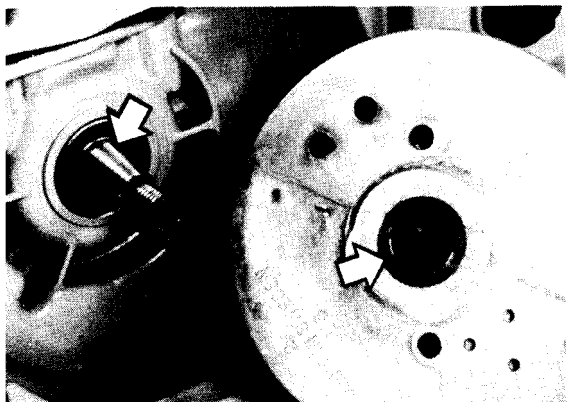

6

On flywheels equipped with two crankshaft key-ways, use the key-way marked "5" for correct ignition timing.

NOTE !

From serial number 9250857 the flywheel key is cast into the flywheel.

Install the flywheel and tighten the flywheel retaining nut to 25-30 Nm (18.4-22.1 ft.lbs.) torque. Check the air gap between the flywheel magnets and the ignition module as instructed in the Ignition Module section.

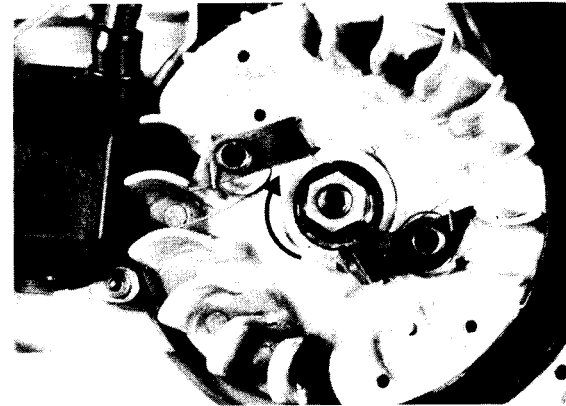
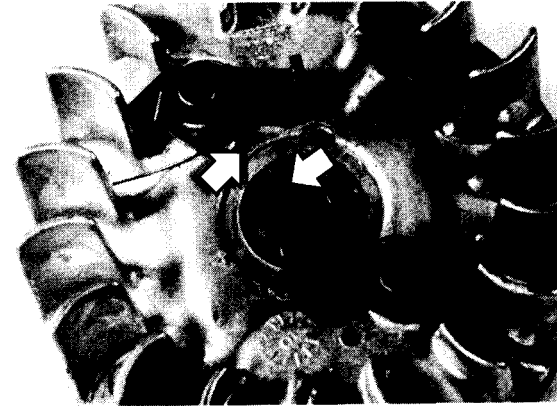

7

Centrifugal Clutch

Disassembly

Remove the spark plug and thread the piston stop P/N 5025033-01 into the spark plug opening in the cylinder.

NOTE !

Make sure that the piston stop is threaded completely into the cylinder.

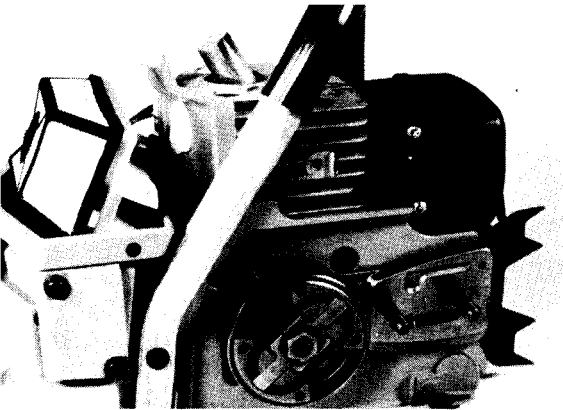

Rotate the clutch clockwise by hand until the piston contacts the piston stop. The clutch hub has left-hand threads. Loosen the clutch hub in a clockwise direction and remove the clutch.

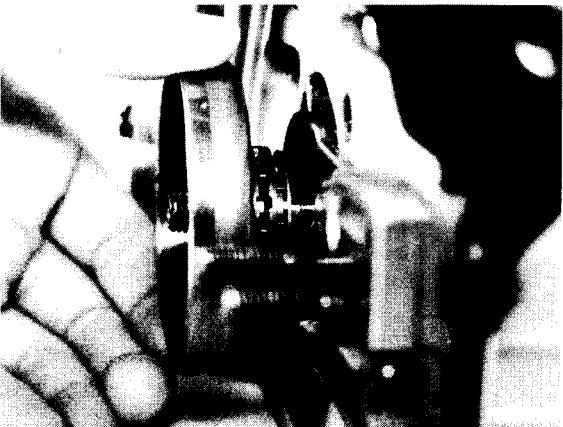

Slide the clutch drum with drive sprocket, needle bearing and washer from the crankshaft. Clean the parts.

7

To separate the clutch shoes and spring from the clutch hub first secure the clutch hub in a suitable vise. Pry one shoe out far enough to remove the spring.

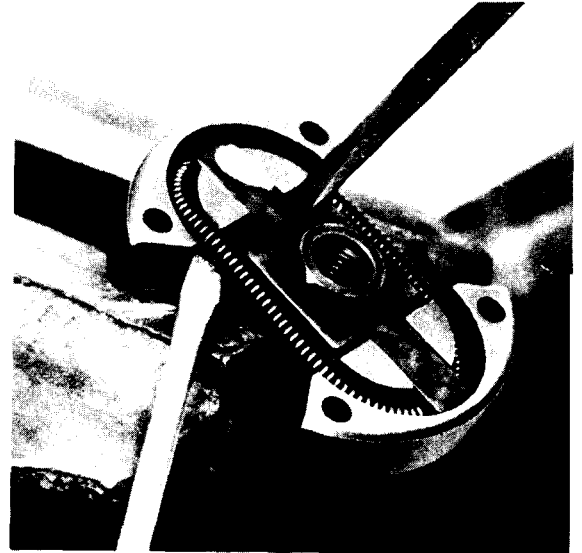

Check the clutch shoes for wear by measuring the material thickness at the shoes thinnest point. If the shoe is worn to less than 1 mm (0.040 in.) of material at the most worn part, the shoes must be exchanged.

NOTE !
When exchanging clutch shoes, always exchange all shoes at the same time.

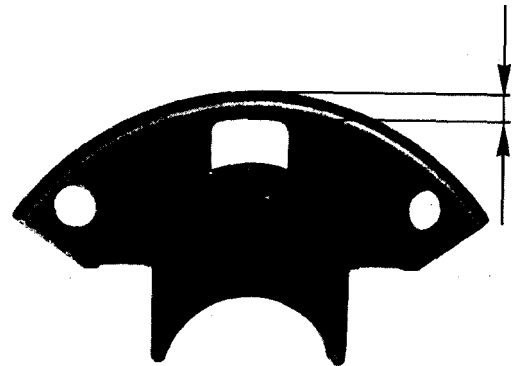

Inspect the clutch hub spokes for wear, Excessive wear causes a jarring sound and poor clutch operation.

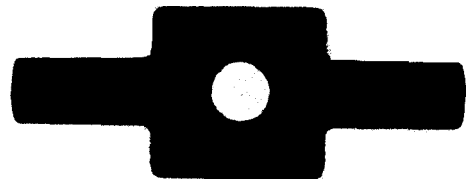

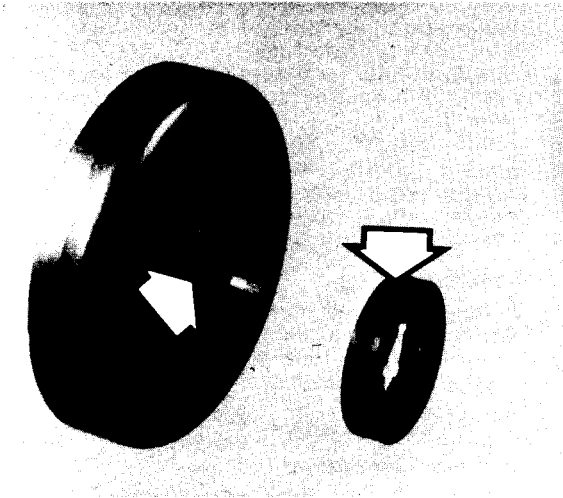

On models equipped with a floating rim sprocket, carefully examine the rim sprocket and the sprocket splines on the clutch drum. On models equipped with a spur sprocket, check for saw chain drive link wear grooves around the spur sprocket on the clutch drum. An excessively worn rim or spur sprocket will cause premature wear of a new chain. Exchange any questionable components.

Assembly

Assemble the centrifugal clutch spring by hooking the ends together. Position the hooked ends of the spring in the middle of a shoe then fit the shoe and spring to the clutch hub.

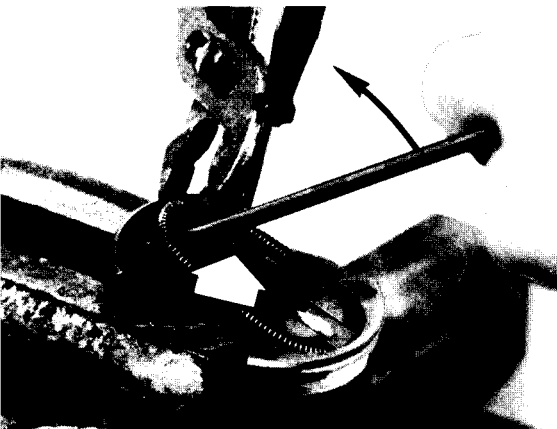
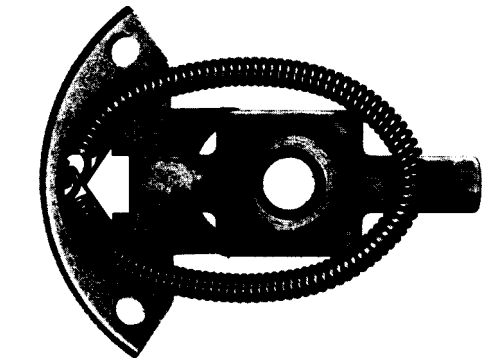

Secure the clutch hub in a vise. With the assistance of a screwdriver and a pair of pliers, lock the remaining clutch shoe so that the spring groove is exposed, then install the spring.

7

On models so equipped, assemble the rim sprocket to the clutch drum. Lightly lubricate the clutch drum needle bearing then slide the washer, needle bearing and clutch drum onto the crankshaft.

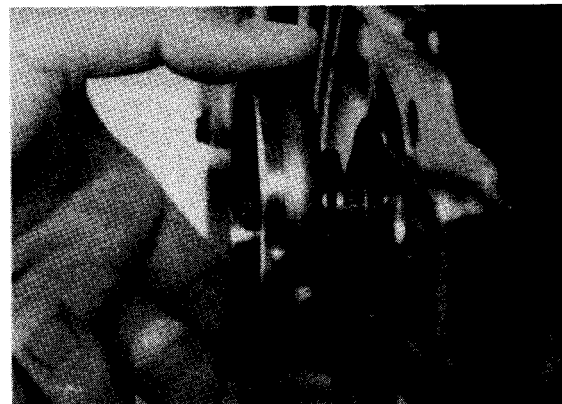

Install the clutch hub and shoes. Tighten the clutch hub to 30-40 Nm (22.1 -29.5 ft. lbs.).

WARNING !

Never start the saw without the bar, chain and chain brake installed. Due to the rapid acceleration and deceleration of the engine, the clutch could come loose and cause severe injuries.

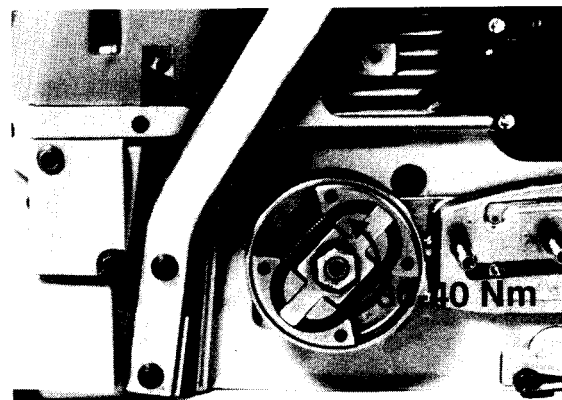

8

Lubrication System, Oil Pump

Disassembly

Pour out the oil and clean the oil tank. Check the oil tank ventilation by slightly pressurizing the tank through the filler opening with compressed air. The oil tank vent is located at the top and to the front of the bar pad. Air should readily pass through the vent. Remove the clutch assembly as instructed in section 7, Centrifugal Clutch.

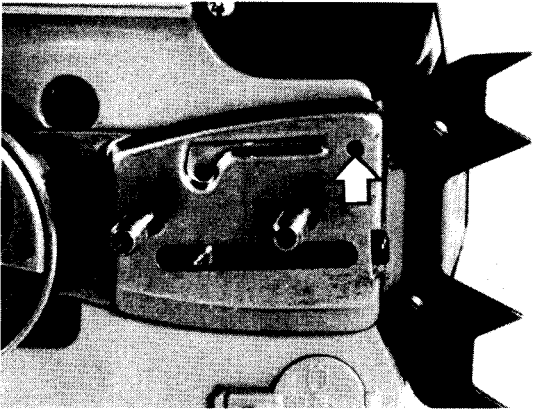

Remove the oil pump cover plate retaining screw and withdraw the cover plate.

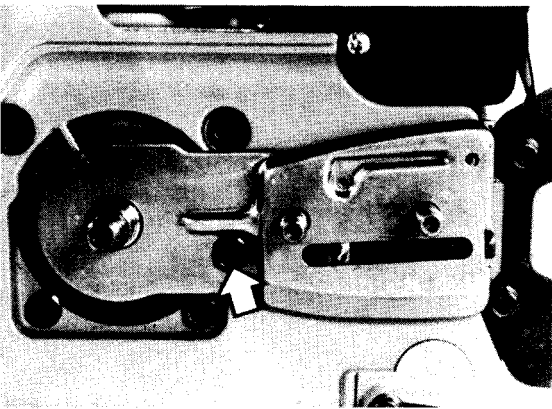

Remove the oil pump assembly from the crankcase.

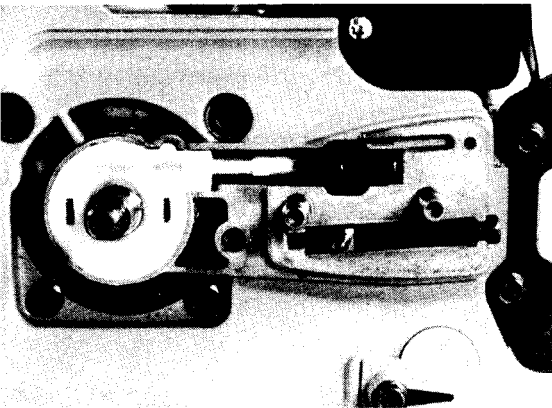

Using a screwdriver, carefully remove the oil suction tube and filter. Clean the oil pick-up filter.

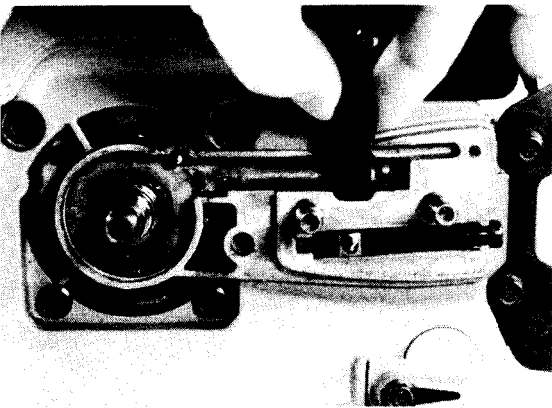

8

Using oil pump drive gear puller P/N 5025026-01 and sleeve P/N 5025099-01, remove the gear from the crankshaft.

Separate and clean the oil pump components. Exchange worn or damaged parts.

Assembly

Thread the oil pump drive gear into the sleeve P/N 5025099-01 until the end of the gear is flush with the end of the sleeve.

Assemble the puller P/N 5025026-01 to the sleeve without the center bolt. Using a brass or plastic faced mallet, drive the gear onto the crankshaft.

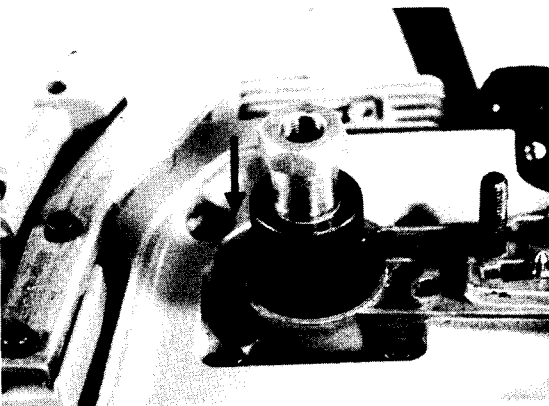
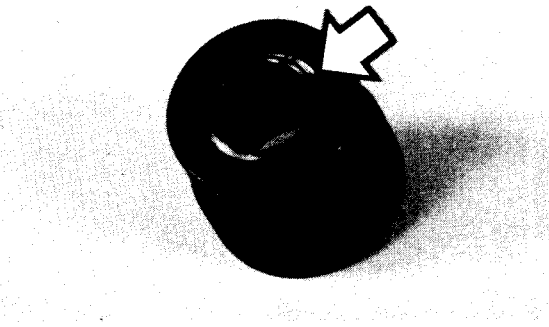
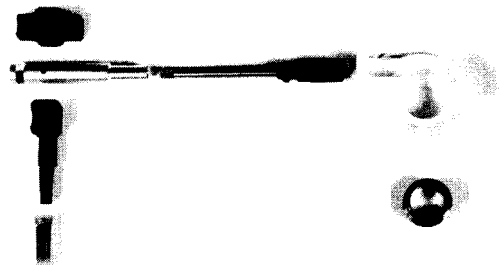
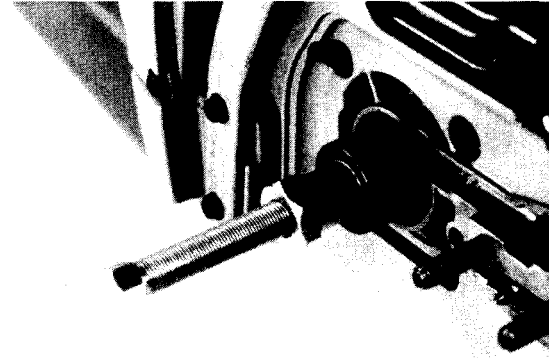

8

After removing the tool, make sure the drive gear is flush against the shoulder on crankshaft.

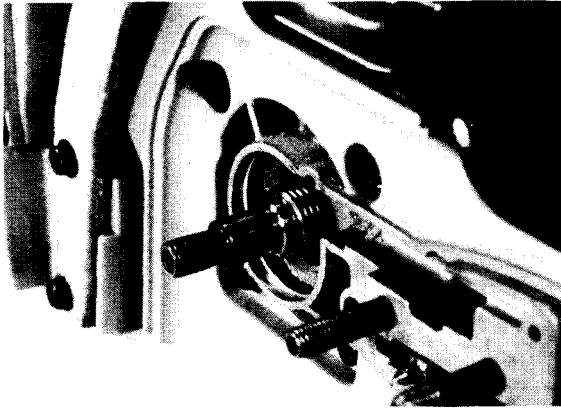

install the oil suction tube and filter in the oil tank.

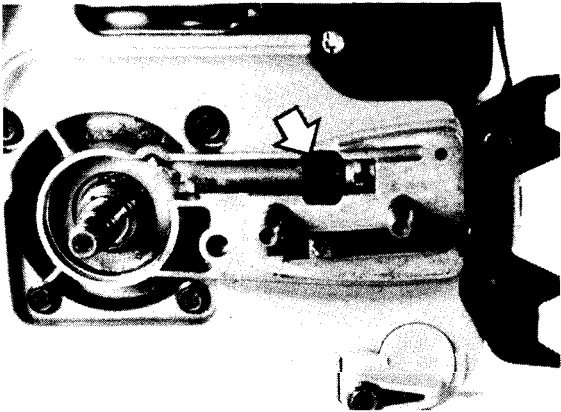

Slip the pump piston into the pump housing. Fill the pump cylinder with grease and slide the cylinder onto the piston.

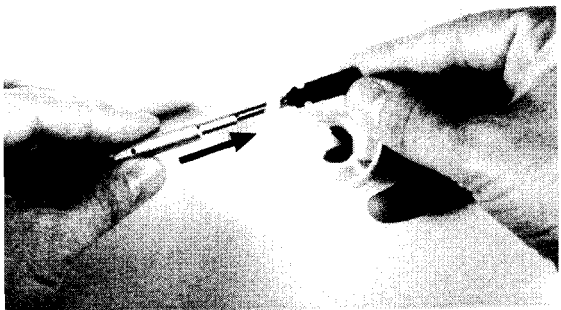

Fit the cylinder into pump housing with the notch in the cylinder towards the back side of the housing.

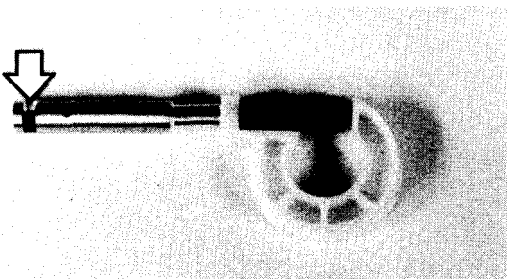

8

Fill the space around the oil pump drive gear with grease. Install the pump assembly into the crankcase ensuring that the pump piston and the pump cylinder engage the corresponding pin and notch in the crankcase. Fit the rubber grommet around the oil discharge port in the pump cylinder.

Install the oil pump cover plate and retaining screw. Assemble the clutch as instructed in section 7, Centrifugal Clutch.

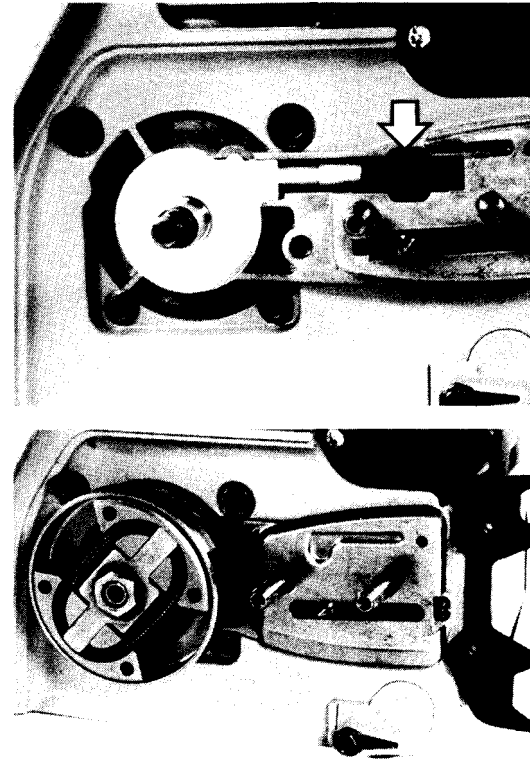

9

Anti-Vibration System

In order to prevent injuries in the operator's hands and fingers caused by vibrations from cutting equipment and the oscillating internal parts of the engine, rubber elements isolate the cutting equipment and engine from the front and rear handles. To maintain the greatest possible protection from vibration during use, the rubber elements should be exchanged at least once a year, regardless of the amount of hours used. If the saw is used continuously the rubber elements should be checked prior to each days use and exchanged as soon as any damage to the elements occur.

NOTE !

All rubber elements should be exchanged at the same time.

Checking the Rubber Elements

If there seems to be excessive movement between the handles and the engine, bar and chain assembly, the rubber elements must be replaced.

Changing the Rubber Elements Disassembly

Four rubber elements are used, two on the left side and two on the right. All four rubber elements are serviceable without major disassembly. For access to the right side rubber elements, first remove the chain brake cover, bar, chain, chain catcher and cover plate.

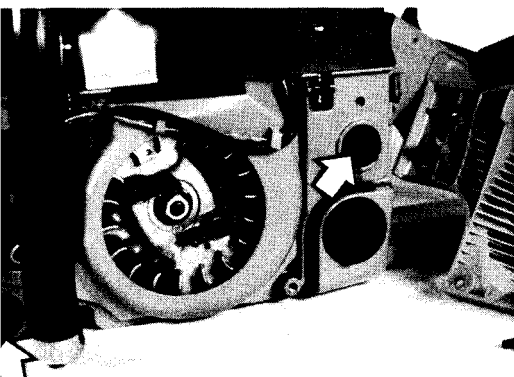
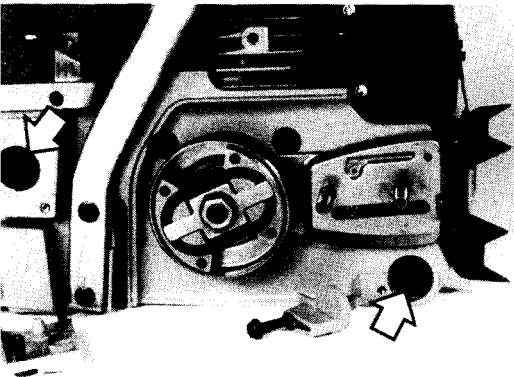

For access to the left side rubber elements, remove the starter housing.

9

Use a screwdriver to remove the rubber elements.

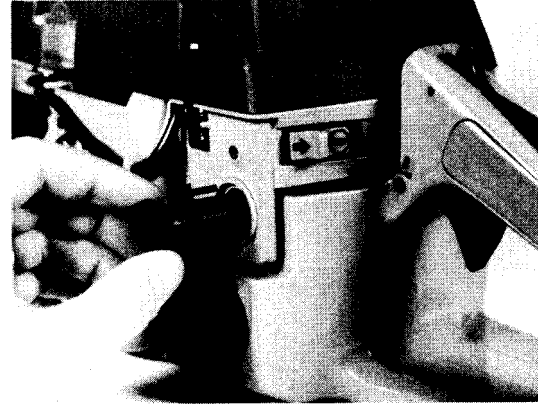

Assembly

Press in the rubber elements. Remainder of reassembly is in the reverse order of disassembly.



Fuel Tank Ventilation

Checking the Fuel Tank Ventilation

Empty the fuel tank. Tighten the fuel tank cap. Disconnect the fuel hose at the carburetor and attach the pressure gauge P/N 5025038-01 to the hose. Pressurize the fuel tank to 50 kPa (7.2 psi) as indicated by the pressure gauge. The pressure should reduce to 20 kPa within 60 seconds (3 psi/60 sec.). The fuel tank ventilation should be serviced if the pressure reduction to 20 kPa takes longer than 60 seconds.

NOTE !

Some two-stroke engine oils and fuel: oil mixture ratios can restrict fuel tank ventilation. If the vent fails the previously described test requiring vent servicing, future fuel tank ventilation problems may be prevented by ensuring that the operator is following the recommended fuel mix instructions in the Operator's Manual supplied with the saw.

Disassembly

The fuel tank vent is located on the right side of the fuel tank next to the right rear rubber element. With the fuel tank empty and the fuel hose disconnected at the carburetor, remove the two rear rubber elements as described in section 9. Anti-Vibration System. Separate the rear of the crankcase and the fuel tank enough to expose the fuel tank vent.

Working through the fuel filler opening, grasp the fuel tank vent tube with a pair of needle nose pliers. Push the vent out the other side.

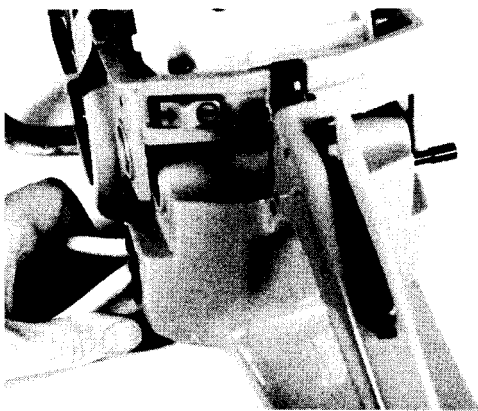
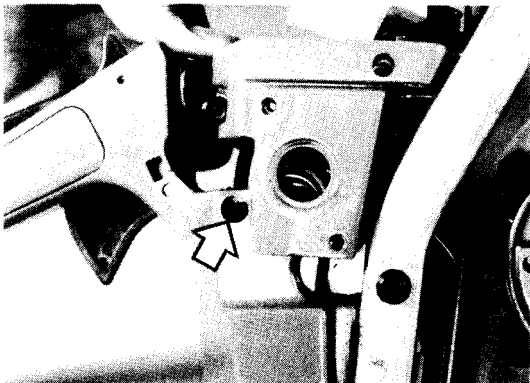
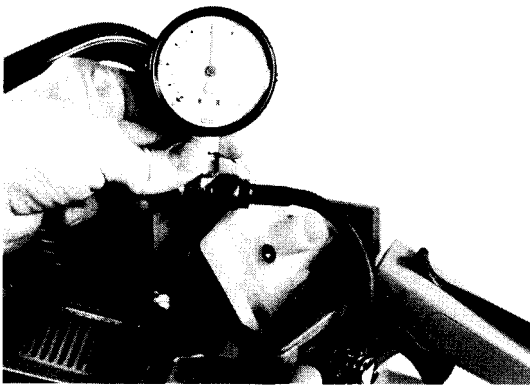

10

Assembly

Install the fuel tank vent using a drift the same diameter as the vent tube. The remainder of assembly is the reverse of disassembly.

NOTE !

The exposed length of the fuel tank hose measured between the fuel tank and the carburetor should be 115 mm (4 1/2 in.)

Carburetor Removal

Remove the air filter and disconnect the fuel hose at the carburetor. Remove the one screw retaining the air filter mounting plate to the crankcase and the two screws retaining the plate and carburetor to the intake manifold.

Remove the air filter plate and carburetor with throttle linkage and (if equipped) choke linkage.

Remove the two screws retaining the intake manifold to the crankcase and remove the manifold. Separate and clean the parts.

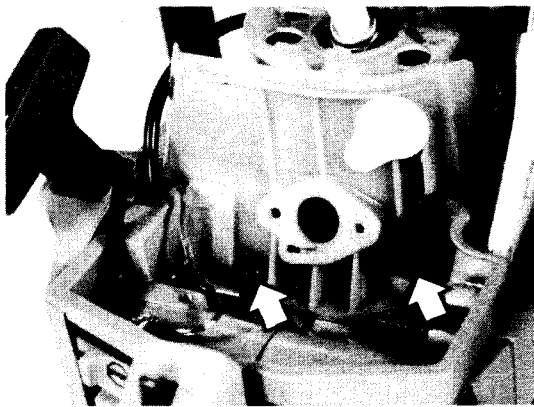
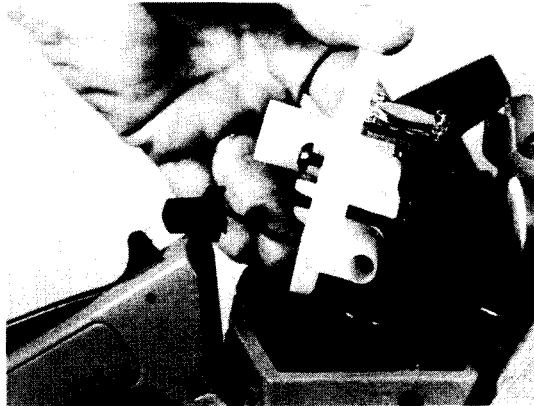
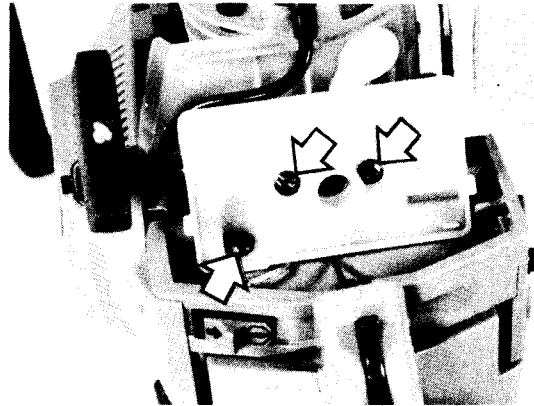
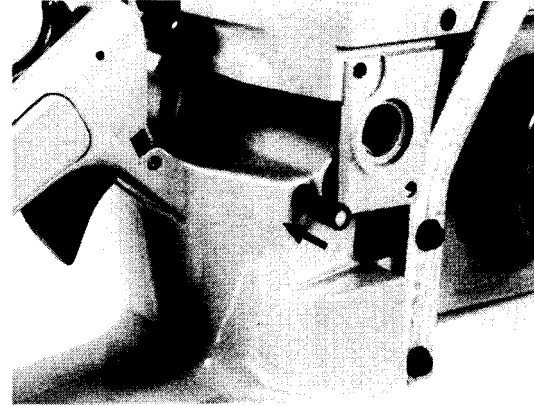

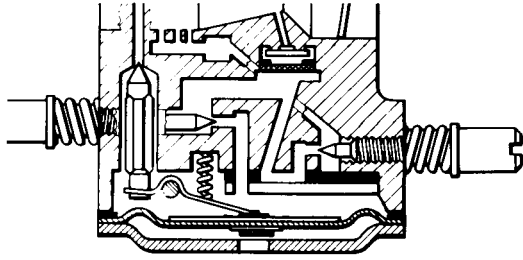

Carburetor Operation

The carburetor is a multi-position, integral diaphragm type which can be divided into three main sections, the metering section, the mixing section and the pumping section.

The metering section consists of the metering diaphragm, the fuel nozzles and the fuel flow control functions.

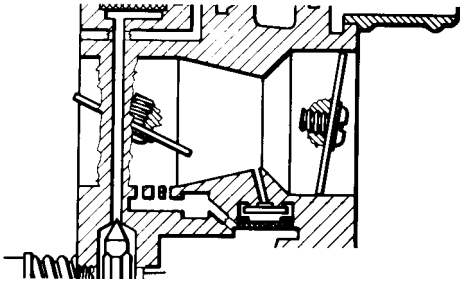

The mixing section consists of the venturi, where the fuel and air are mixed and where the throttle valve and (on the model 51 and 55) the choke valve are located.

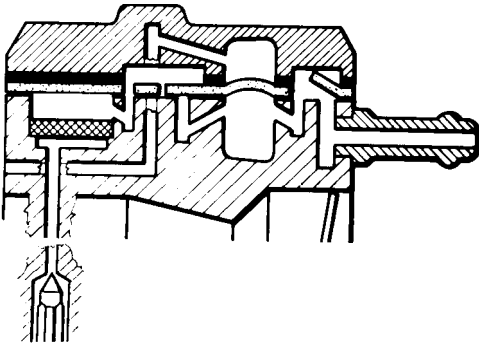

The pumping section consists of the fuel chamber and the diaphragm type fuel pump with the inlet and outlet check valves. The fuel pump draws the fuel from the tank to the fuel chamber, then pushes the fuel on to the metering section.

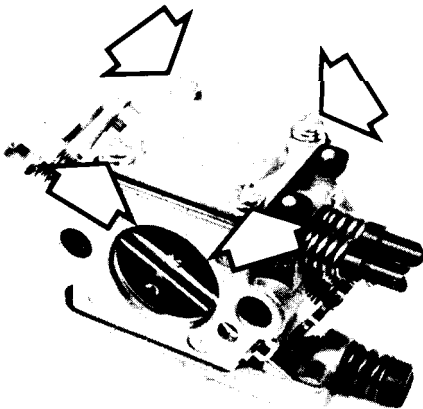

Disassembly

NOTE !

The internal passages of the carburetor body are delicate and are easily damaged if proper service procedures are not used. Damage to the fuel passages and seats is not repairable and will necessitate the installation of a new carburetor. Make sure the work area is clean and exercise extreme care during disassembly, cleaning and reassembly of the carburetor.

Remove the screws retaining the metering diaphragm cover and remove the cover. Carefully remove the metering diaphragm and gasket.

10

Test the fuel inlet lever, spring, needle valve and seat condition. Connect the pressure gauge P/N 5025038-01 to fuel inlet fitting on the carburetor. Immerse the carburetor in a suitable container of fuel. Pressurize the carburetor to 50 kPa (7.2 psi). No air leakage is permitted.

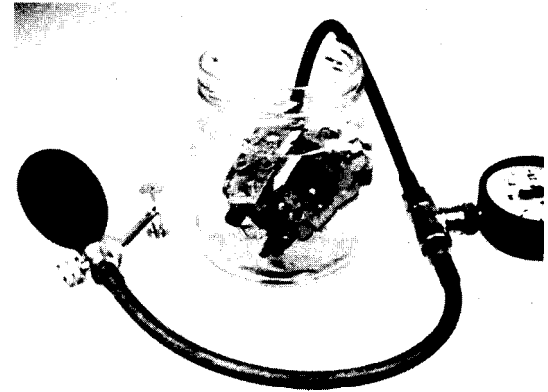

If air leakage is observed, remove the screw retaining inlet lever pivot shaft and carefully remove the lever shaft, spring and needle valve.

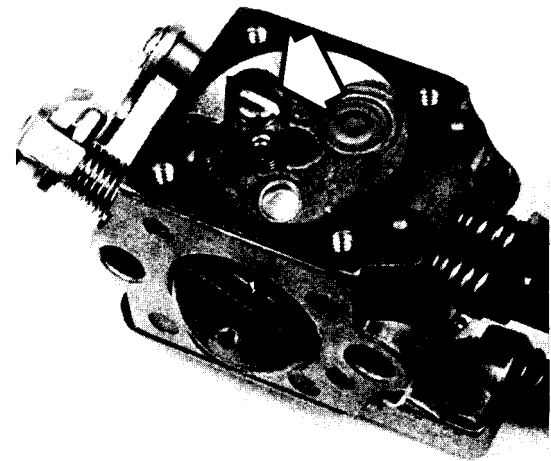

Check the needle valve. Replace a damaged or worn needle valve.

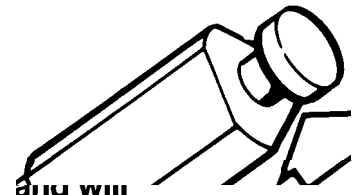
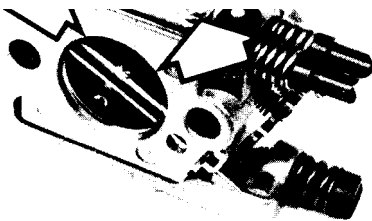

and will necessitate the installation of a new carburetor. Make sure the work area is clean and exercise extreme care during disassembly, cleaning and reassembly of the carburetor.

Remove the screws retaining the metering diaphragm cover and remove the cover. Carefully remove the metering diaphragm and gasket.

10

Check the lever. Replace a damaged or worn lever.

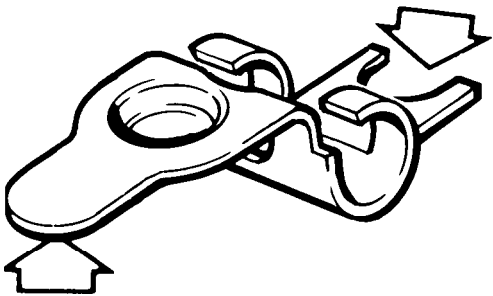

Remove the one screw retaining the fuel pump cover and remove the cover. Carefully remove the fuel pump diaphragm gasket and fuel pump diaphragm.

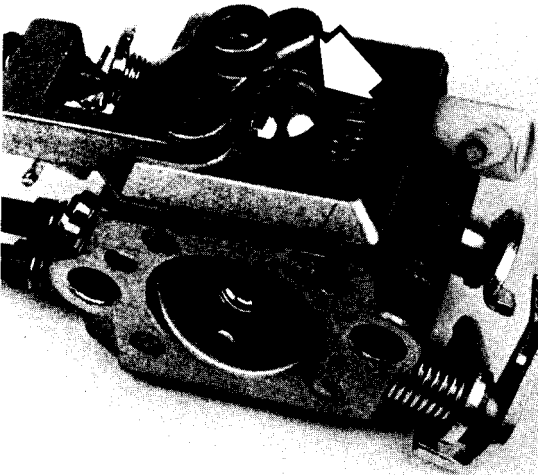

Using a pick, carefully remove the fuel inlet screen.

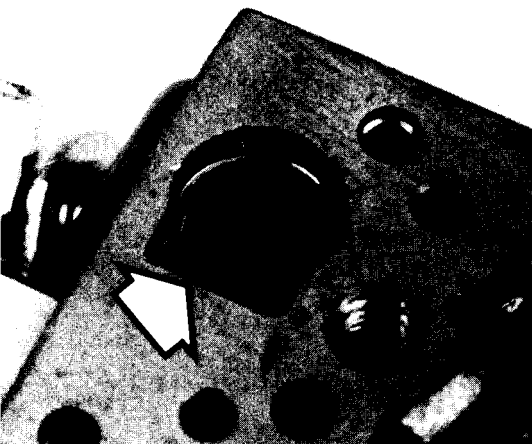

10

Remove the low and high speed mixture screws.
Exchange the mixture screws if the screw tips are bent or damaged.

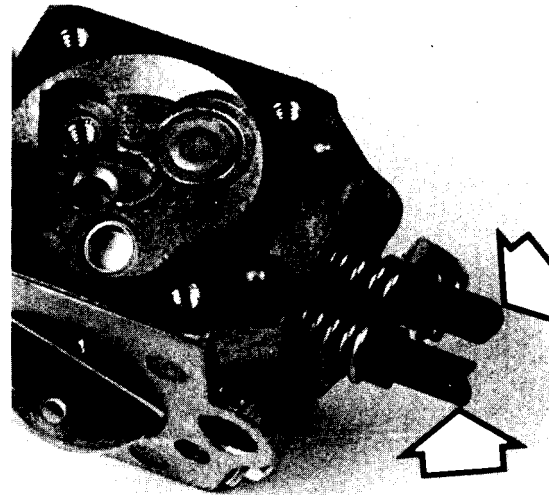

If the carburetor is very dirty it will be necessary to clean the fuel passages located underneath the fuel circuit plate (Walbro WA) or the welch plug(s) (Walbro WT).

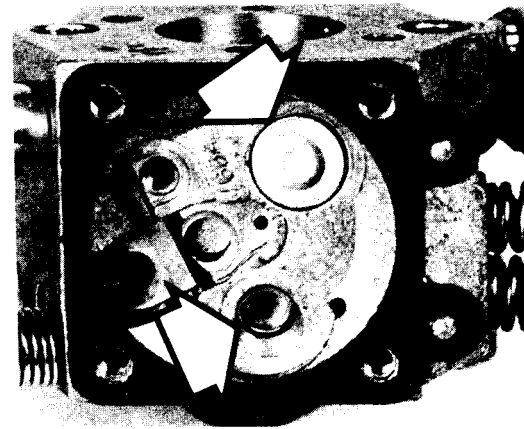

To remove a welch plug very carefully punch a hole through the center of the plug. Pry the plug sideways to remove the plug from its seat.

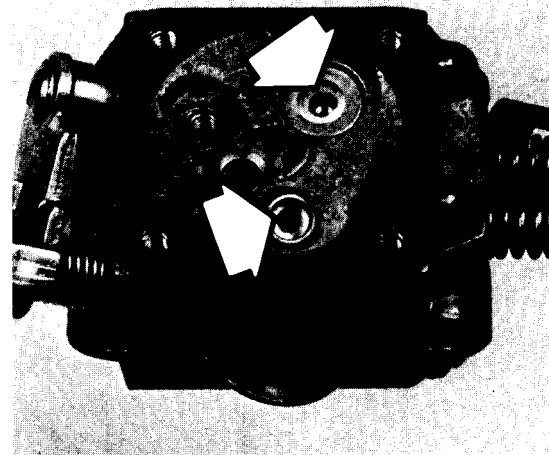

10

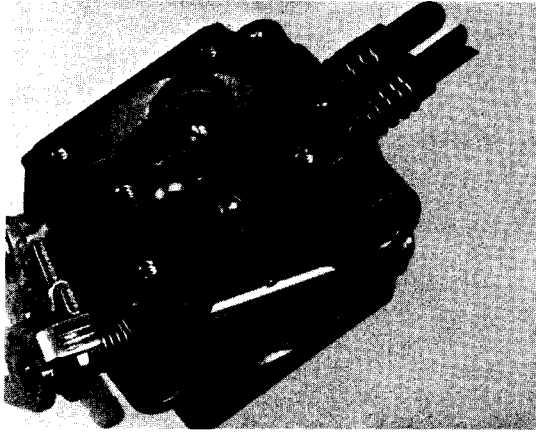

Clean the carburetor body and blow out all passages and channels with low pressure compressed air.

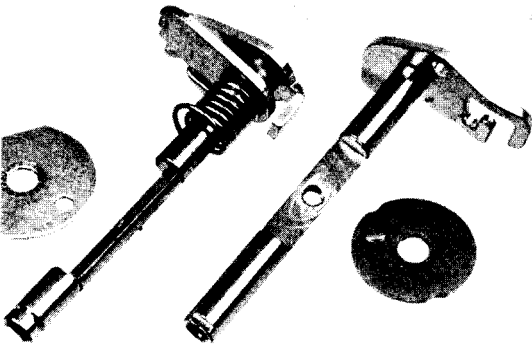

Check the throttle and (if equipped) choke valves and shafts for wear and exchange if necessary.

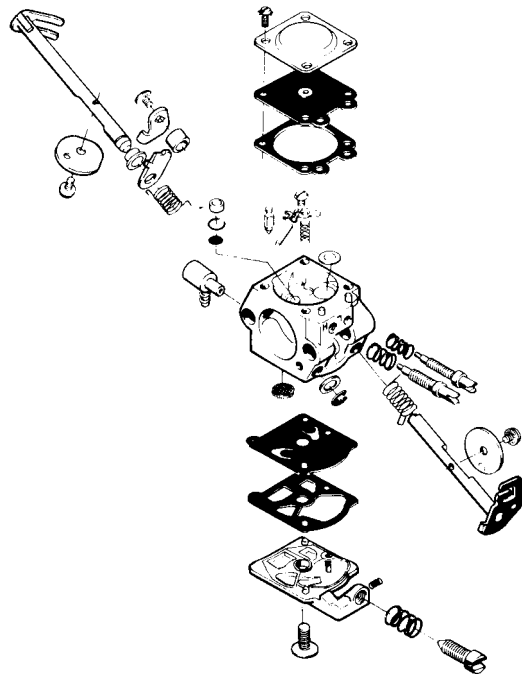

Assembly

New gaskets, diaphragms, fuel inlet screen and welch plugs must be used to ensure correct carburetor function.

10

Begin assembly with the fuel metering side. Install the fuel mixture adjustment screws. Depending on the carburetor type, either install the fuel circuit plate and gasket or the welch plugs. Use a suitable drift to install welch plugs. Install the needle valve, spring, lever and shaft.

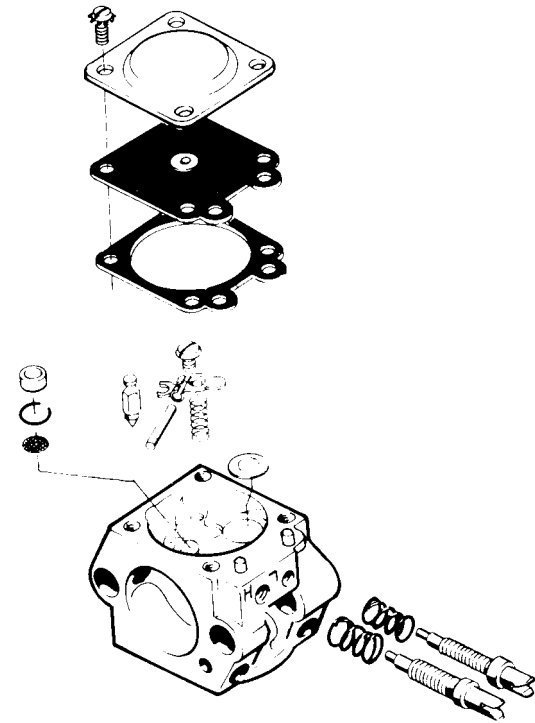

Check and adjust the tip of the fuel inlet lever. Correct lever adjustment is critical. An incorrect lever setting will cause erratic engine operation. On Walbro WA carburetors, the tip should be flush with the fuel chamber floor. On Walbro WT carburetors, the lever tip should be flush with the raised casting next to the lever on the fuel chamber floor.

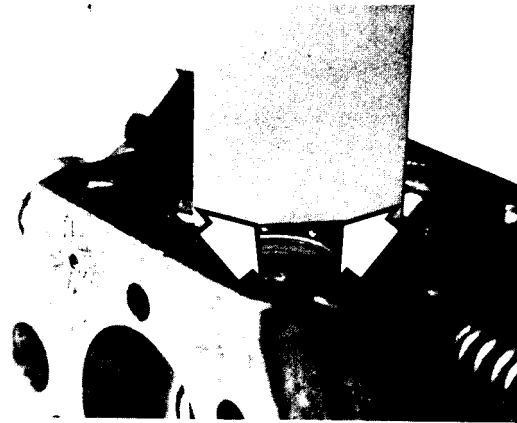

Install the metering diaphragm gasket against the carburetor body first, followed by the metering diaphragm and cover. The cover should be positioned so that the diaphragm ventilation hole is towards the cylinder.

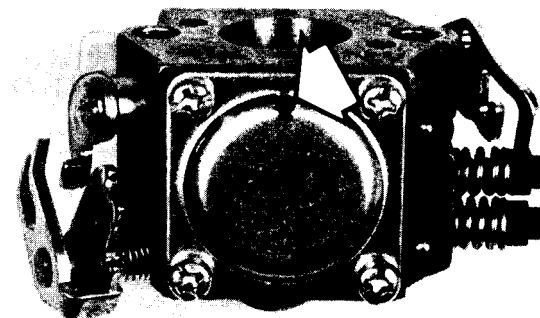

10

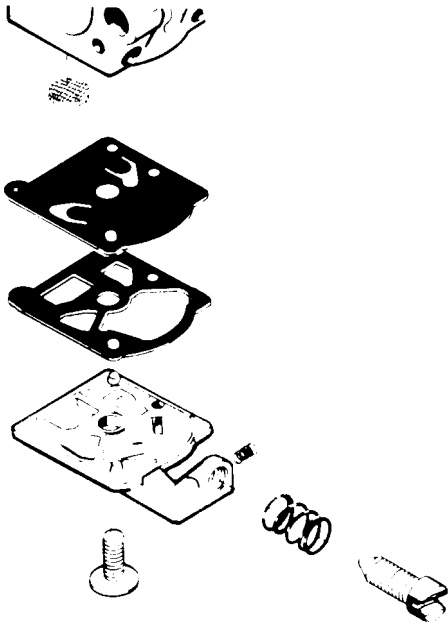

Assemble the fuel pump section. Press the fuel inlet screen into its seat evenly. Install the fuel pump diaphragm against the carburetor body first, followed by the gasket and cover.

After assembly, pressure test the carburetor for air leaks. Pressure test at 50 kPa (7.2 psi). No air leaks are permitted.

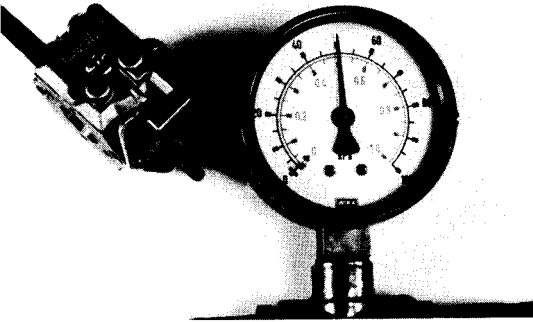

On carburetors equipped with choke valves, check that the levers of the fast idle system are not worn and that they have positive engagement.

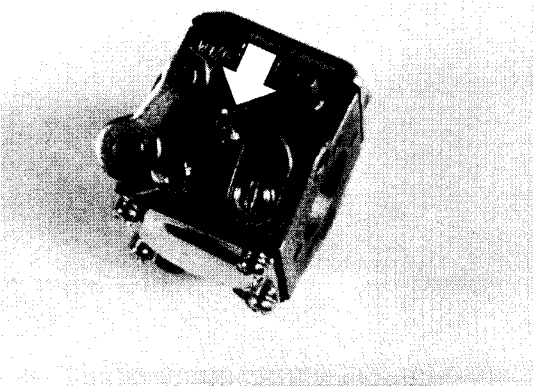

10

Carburetor Installation

Check the fuel pump pulse passage in the intake manifold to ensure that it is open and clean.

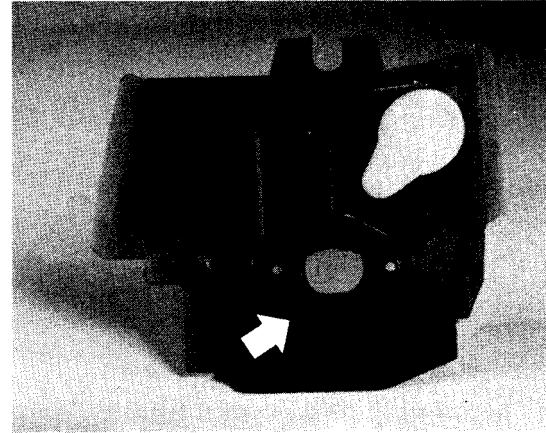

Check the pulse passage seal and rubber intake tube on the cylinder. Exchange the seal and tube if the material has hardened or is damaged.

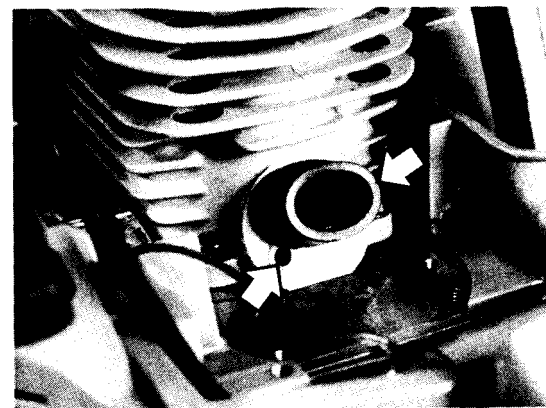

Apply a very thin coat of grease around the tip of the pulse passage tube on the manifold and install the manifold.

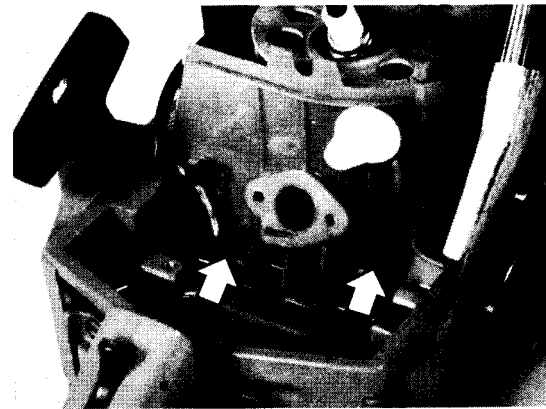

10

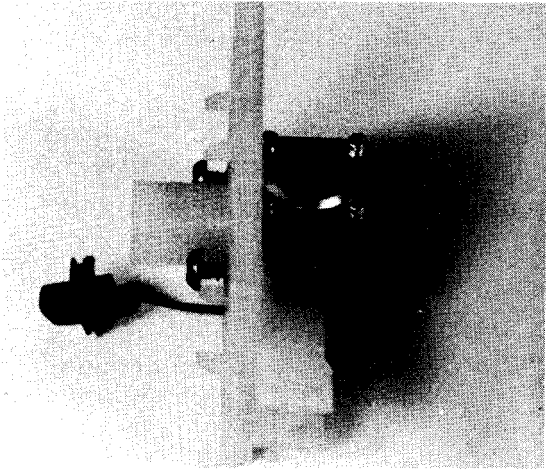

Mount the carburetor to the air filter plate and insert the retaining screws. Attach the throttle and (if equipped) the choke linkage.

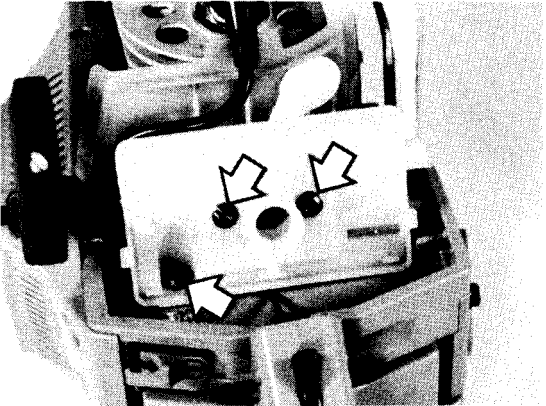

Install the carburetor. Make sure the gasket between the carburetor and manifold is installed correctly. Tighten the retaining screws evenly. Install the air filter plate to crankcase retaining screw. The remainder of installation is the reverse of removal.

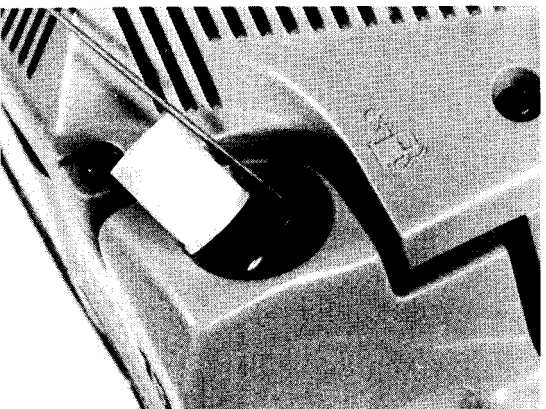

Changing the Fuel Filter

The fuel filter is changed through the fuel filler opening using tool P/N 5025083-01. After changing the filter, make sure the external length of the fuel hose between the fuel tank and the carburetor is 115 mm (4-1/2 in.).

Carburetor Adjustment

WARNING !

Never start the saw without the bar, chain and chain brake installed. Due to the rapid acceleration and deceleration of the engine, the clutch could come loose and cause severe injuries.

Ensure that the air filter and fuel filter are clean before making carburetor adjustments. The carburetor adjusting screws are located on the right side of the saw and are identified as follows: L = low speed mixture screw, H = high speed mixture screw and T = idle (throttle) speed screw.

Basic Adjustment

Before attempting to perform a running adjustment, first make a basic adjustment of the L and H mixture screws. Rotate the L and H mixture screws in (clockwise) until lightly seated.

NOTE !

Damage to the mixture screw tips and tip seats may result if the screws are over tightened.

Now open (counterclockwise rotation) each mixture screw one full turn.

Final Adjustment

NOTE !

A suitable two-stroke single cylinder tachometer such as the one supplied by Husqvarna P/N 5027114-01 must be used to ensure correct engine operating rpm's preventing possible unnecessary and costly engine damage.

Start the saw and allow the engine to reach normal operating temperature. If necessary, adjust screw 'T' so that an engine idle rpm of 2500-2800 is achieved. The saw chain must not rotate at engine idle.

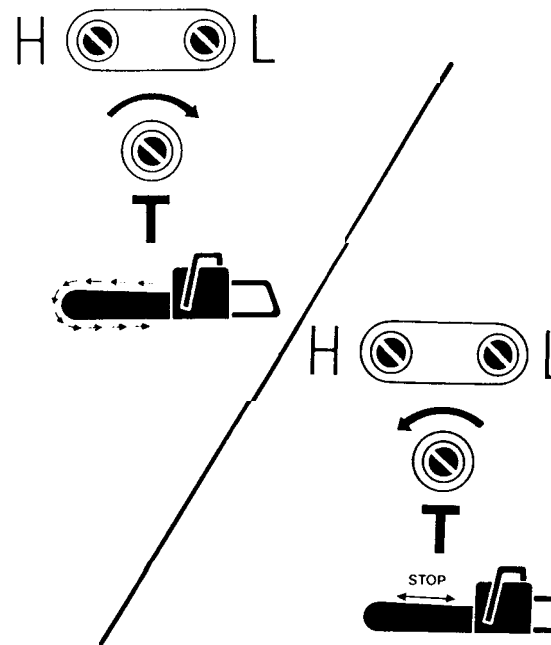
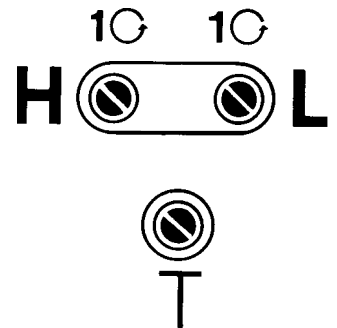
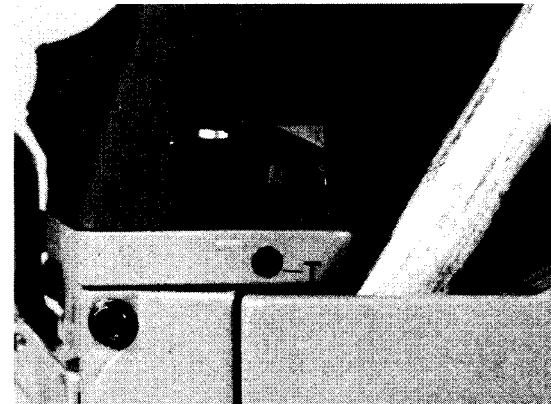

10

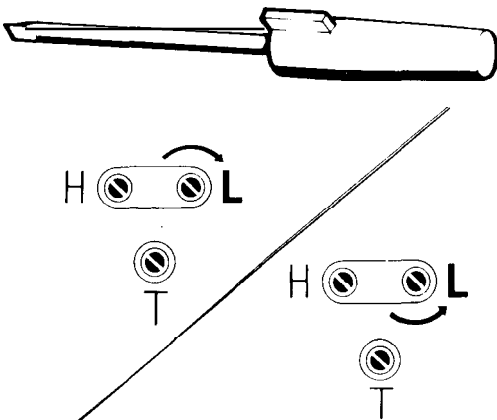

Begin with the low speed mixture screw. Using carburetor screwdriver P/N 5016002-02, turn the L screw in until the engine rpm's just start to decrease and note the screwdriver position. This is referred to as the lean drop setting. Now turn the L screw out until the engine rpm's just start to decrease again and note the screwdriver position. This is referred to as the rich drop setting.

Turn the L screw back in to the mid-point between the lean and rich drop off settings, then open 1/4 turn. Adjust the idle speed to 2500-2800 rpm with the T screw again if necessary then recheck the L screw adjustment as previously described.

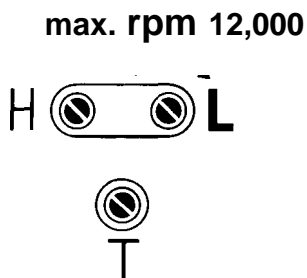
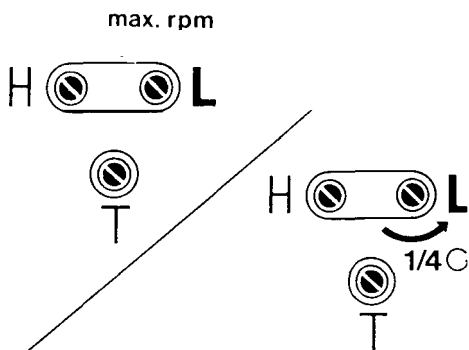

With the low speed mixture adjusted, the high speed mixture (screw H) is ready for adjustment. Run the engine at wide open throttle while observing the tachometer. Adjust the H screw so that the maximum no-load speed does not exceed 12500 rpm. After setting the high speed mixture, allow the engine to return to idle speed, then check for hesitation on acceleration. Repeat the complete final adjustment procedure of both the L and H mixture screws if necessary.

Trouble-shooting Chart

Start

| | 1 | 2 | 3 | 4 | 5 | 6 | 7 | 8 | 9 | 10 | 11 | 12 | 13 | 14 | 15 | 16 | 17 | 18 | 19 | 20 | 21 | 22 | 23 | 24 | 25 |
|---|---|---|---|---|---|---|---|---|---|----|----|----|----|----|----|----|----|----|----|----|----|----|----|----|----|
| A | ● | | | ● | ● | | | | | | | ● | | | | | | | | | | ● | ● | ● | |
| B | | | | | | | ● | | | ● | | | | | | | | | | | | | | | |
| C | | | | | | | | | | | | | | | | | | | | | | | | | |

Idle

| | | | | | | | | | | | | | | | | | | | | | | | | | |
|---|---|--|---|---|---|---|---|---|--|--|--|---|---|---|---|--|---|---|---|---|--|--|--|--|---|
| D | ● | | ● | ● | ● | ● | ● | | | | | ● | ● | | | | ● | ● | ● | ● | | | | | |
| E | ● | | | | | | | | | | | | | | | | | | | | | | | | |
| F | | | | | | | | | | | | | | | | | | | | | | | | | |
| G | | | | | | | ● | ● | | | | | ● | ● | ● | | ● | | | | | | | | ● |
| H | | | | | | ● | | | | | | | | | | | | | | | | | | | |
| J | | | | | | | | | | | | | | | | | | | | | | | | | |

Acceleration, Deceleration

| | | | | | | | | | | | | | | | | | | | | | | | | | |
|---|---|---|---|---|---|---|---|--|---|---|---|---|---|---|--|--|--|--|--|--|--|--|--|--|--|
| K | ● | ● | ● | ● | ● | ● | ● | | ● | ● | ● | ● | ● | ● | | | | | | | | | | | |
| | ● | ● | | | | | | | | | ● | | | | | | | | | | | | | | |
| M | ● | ● | | | | | | | | | ● | ● | | | | | | | | | | | | | |

High Speed

| | | | | | | | | | | | | | | | | | | | | | | | | | |
|---|--|---|---|---|---|---|---|---|---|---|---|---|---|---|--|--|--|--|--|--|--|--|--|--|--|
| N | | ● | ● | ● | ● | ● | ● | ● | ● | ● | ● | ● | | | | | | | | | | | | | |
| O | | ● | ● | ● | | | | ● | ● | ● | ● | ● | | | | | | | | | | | | | |
| P | | | ● | ● | ● | ● | ● | ● | ● | ● | ● | | ● | ● | | | | | | | | | | | |

Start

- A. Hard starting
- B. Fuel dripping from carburetor
- C. Floods engine when not running

Idle (Low speed)

- D. Will not idle
- E. Rich idle
- F. Idles with needle closed
- G. Erratic idle
- H. "L" needle needs frequent adjustment
- J. Loads up while idling

Acceleration, deceleration

- K. Will not accelerate
- L. Engine stops when closing throttle
- M. Over-rich acceleration

High Speed

- N. Will not run at full throttle
- O. Low power
- P. Will not 4 cycle (No rich drop off)

10

Trouble-shooting Chart

Start

| | 26 | 27 | 28 | 29 | 30 | 31 | 32 | 33 | 34 | 35 | 36 | 37 | 38 | 39 | 40 | 41 | 42 | 43 |
|---|----|----|----|----|----|----|----|----|----|----|----|----|----|----|----|----|----|----|
| A | | | | | | | | | | | | | | | | | | |
| B | | ● | | | | | ● | | | ● | | ● | ● | ● | ● | ● | | |
| C | | ● | | | | | | | | | | | | ● | ● | ● | | |

Idle

| | | | | | | | | | | | | | | | | | | |
|---|---|---|--|---|---|---|---|---|--|---|--|---|---|---|---|---|---|---|
| D | | | | | | | | | | | | | | | | | | ● |
| E | ● | ● | | ● | | | | | | | | | | ● | ● | ● | ● | |
| F | | ● | | ● | | | | | | | | | | ● | ● | ● | ● | ● |
| G | | | | ● | | | ● | ● | | | | ● | ● | ● | ● | | | ● |
| H | | ● | | ● | | | ● | | | ● | | | | | ● | | ● | ● |
| J | | ● | | ● | ● | ● | | | | | | | | ● | ● | ● | ● | |

Acceleration, Deceleration

| | | | | | | | | | | | | | | | | | | |
|---|--|---|---|--|--|--|--|--|--|---|--|--|--|--|--|---|--|---|
| K | | | ● | | | | | | | ● | | | | | | ● | | ● |
| L | | ● | | | | | | | | | | | | | | ● | | ● |
| M | | | | | | | | | | | | | | | | | | ● |

High Speed

| | | | | | | | | | | | | | | | | | | |
|---|--|--|---|---|---|---|---|--|---|---|---|---|---|---|---|---|--|---|
| N | | | ● | ● | ● | ● | | | | | | | | ● | ● | ● | | |
| O | | | | ● | | | ● | | ● | ● | ● | ● | ● | | | | | ● |
| P | | | ● | | | | ● | | ● | ● | ● | ● | ● | | | | | |

Metering System

26. Worn lever
27. Set too high
28. Set too low
29. Not free
30. Distorted
31. Improperly installed
32. Leaking (air/fuel)
33. Worn button
34. Improper assembly
35. Defective gasket
36. Loose diaphragm rivet

37. Hole in diaphragm

38. Loose cover screws
39. Foreign matter
40. Binding
41. Worn needle body or tip

Circuit Plate

42. Loose screws, bad gasket
43. Nozzle check valve

Adjustments

1. Low speed needle
2. High speed needle

Fuel System

3. Plugged tank vent
4. Plugged tank filter
5. Restricted fuel line
6. Dirt in fuel passage
7. Loose, damage fuel line
8. Leak in pulse system
9. Restricted pulse channel
10. Loose pump cover screws
11. Defective pump diaphragm

Air System

12. Plugged air filter
13. Defective manifold gasket
14. Loose carb. mounting bolts
15. Worn throttle assembly
16. Incorrect throttle assembly
17. Loose throttle valve screw
18. Throttle shaft too tight
19. B&t throttle linkage
20. Defective throttle spring
21. Bent throttle stop lever
22. Choke not functioning properly
23. Worn choke shaft
24. Worn choke valve
25. Worn throttle valve

Exhaust System

11

The law in some countries requires that the exhaust system be equipped with a spark arrester screen. Check the screen and clean or exchange it if necessary. A clogged or even partially clogged spark arrester screen will cause poor engine performance and overheating resulting in potential piston and cylinder damage.

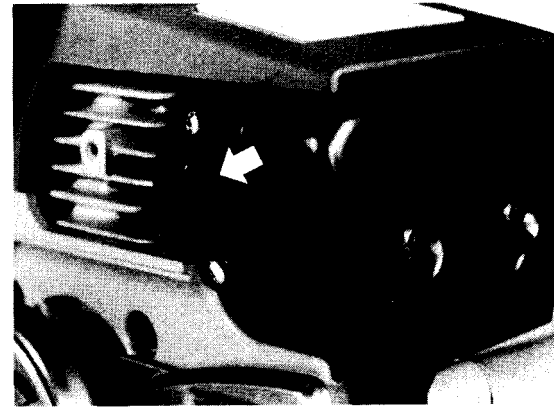

12

Cylinder & Piston

Disassembly

Remove the cylinder cover and air filter. Clean around the cylinder base to prevent dirt and debris from entering the crankcase when the cylinder is removed.

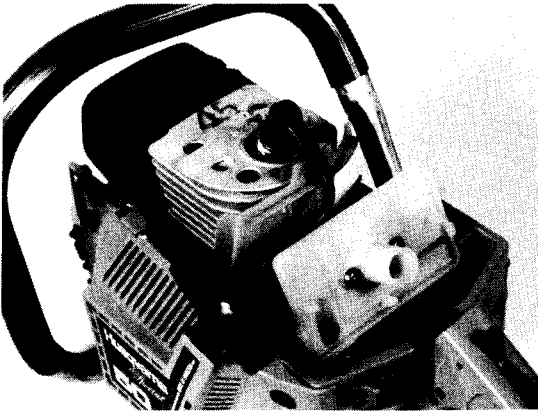

Remove the carburetor and intake manifold as described in section 10. Fuel System. Remove the spark plug and the exhaust system.

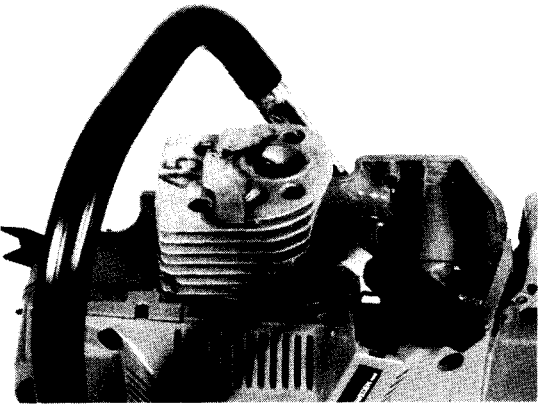

Remove the four screws retaining the cylinder to the crankcase with the 8 mm T-handle wrench P/N 5025022-01. Carefully lift the cylinder straight up off the crankcase and piston.

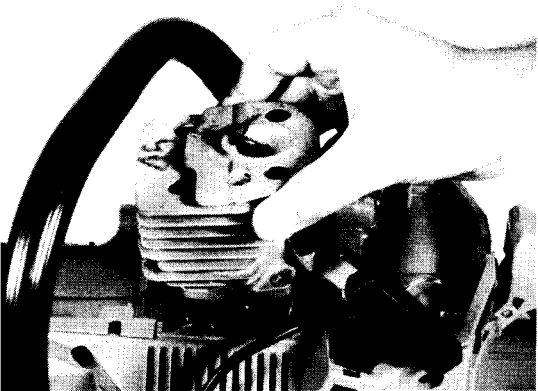

Cover the crankcase opening with a clean cloth wrapped around the connecting rod. Remove the piston pin retaining clips and push the pin out. Separate the piston from the connecting rod. Clean the carbon from the piston crown.

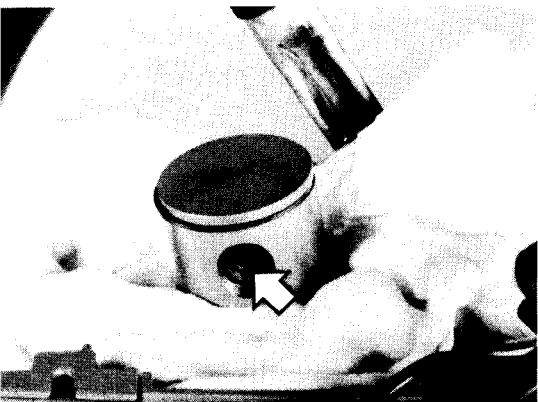

Remove the wrist pin needle bearing from the connecting rod.

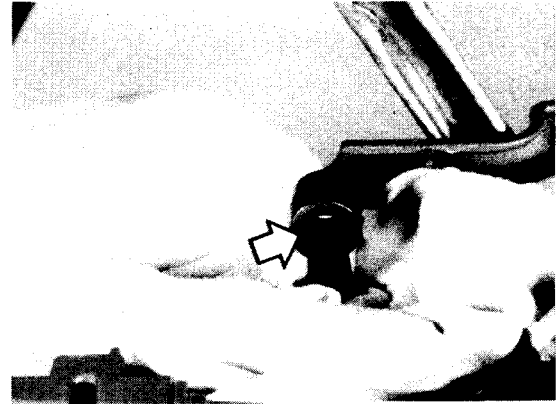

| Fault | Remedy |
|--|--|
| Broken cooling fins, damaged threads or broken screw at the exhaust port. | In serious cases - change the cylinder. Repair the thread Heli-Coil-inserts. |
| Seizure marks in the cylinder wall (especially at the exhaust port). | Grind the damaged spot with a fine emery cloth so that the adhered aluminum disappears. When deeper seizure scratches occur, the cylinder and piston should be exchanged. |
| Surface coating in the cylinder wall worn (mainly at the top of the cylinder). | Exchange the cylinder and piston. |
| The piston has seizure marks. | Carefully grind the damaged spot with a fine file or a emery cloth. Before the piston is reassembled, the cylinder should be grinded, as above. When deeper scratches occur, the piston should be exchanged and also the cylinder, if necessary. |
| The piston ring is stuck in its groove. | Loosen the piston ring carefully and clean the groove very carefully before reassembly. Check the piston ring for wear by placing it in the bottom part of the cylinder. |

Assembly

Clean the cylinder base to crankcase contact surfaces making sure that all used gasket material is removed. Position the new cylinder base gasket on the crankcase. A small amount of grease maybe applied to hold the gasket in place. Lubricate the wrist pin needle bearing with oil and insert the bearing into the connecting rod small end.

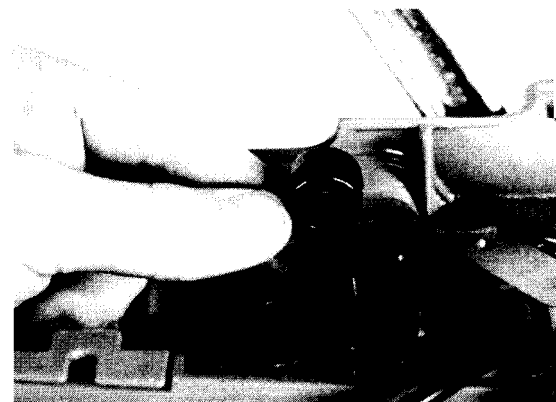

12

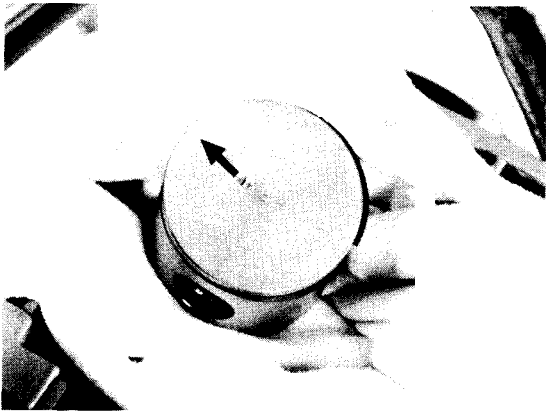

Position the piston over the connecting rod with arrow on the piston crown pointing towards the exhaust side. Align the piston pin boss holes with the connecting rod pin hole and install the pin. Carefully install the wrist pin clips ensuring that the clips are fully seated in the retaining grooves. Lubricate the piston and piston ring with oil.

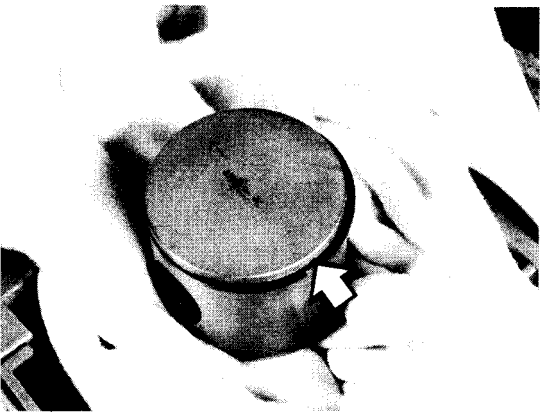

A pin is located within the piston ring groove on the intake side of the piston to prevent ring rotation. Make sure the ends of the piston ring are on either side of the piston ring retaining pin.

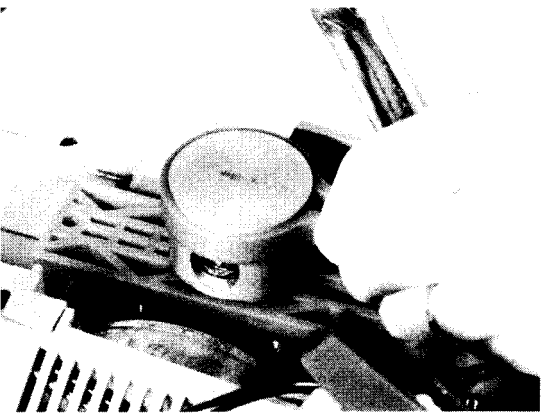

Using the piston/cylinder mounting set P/N 5025070-01, compress the piston ring with the appropriate ring compressor.

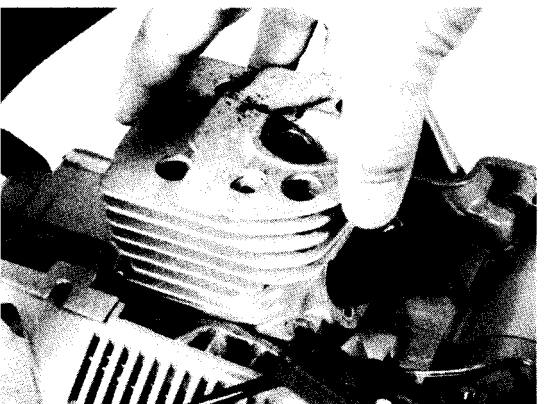

Carefully install the cylinder over the piston and ring. Tighten the cylinder retaining screws in a cross pattern. The remainder of reassembly is in the reverse order of disassembly.

Crankcase & Crankshaft

13

Changing a Bar Stud

Empty and rinse out the oil tank. Using a drift, tap the bar stud into the oil tank. Extract the stud through the oil filler opening. Insert a smaller diameter wire through the bar stud hole in the crankcase and out the oil filler opening. Wrap the end of the wire around the bar stud threads, then guide the stud through the oil tank and stud hole. Remove the wire. Place a sleeve or washers over the stud. Thread a stud nut down onto the stud to pull the stud into its seat.

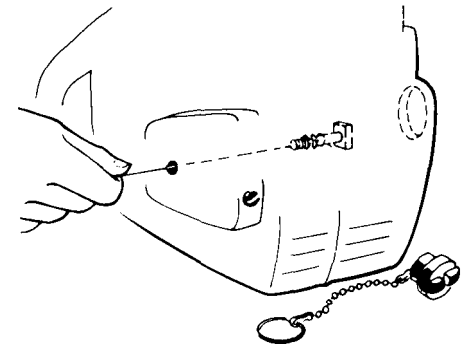

Changing the Crankshaft Seals

The crankshaft seals are accessible after removing the flywheel as instructed in section 6. Ignition System and the oil pump as instructed in section 8. Chain Lubrication System. The seals can be pried out using a suitable screwdriver. Be careful not to scratch or damage the crankshaft during seal removal.

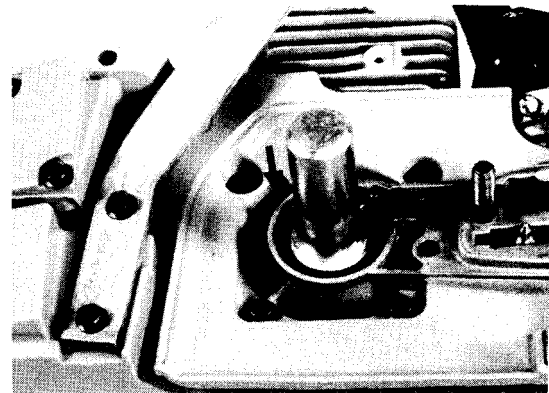
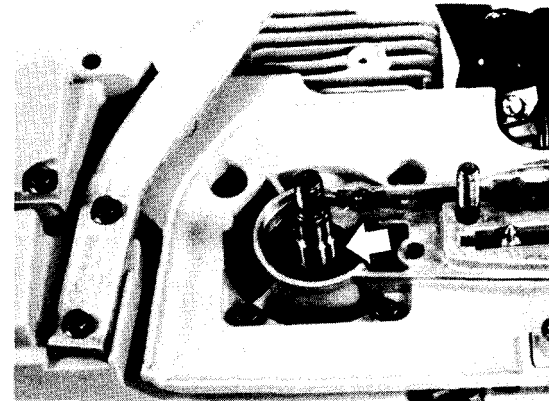

Always use new crankshaft seals for assembly. Begin with the ignition side. Apply grease to the crankshaft seal lip and carefully slide the seal over the end of the crankshaft. The open side of the seal must face inward. Drive the seal into the crankcase using tool P/N 5025079-01 until the seal is flush with the crankcase. Install the drive side crankshaft seal in the same manner. Reverse disassembly procedure for the remainder of assembly.

Crankcase Disassembly

Remove the oil pump, flywheel, piston and cylinder as described in the appropriate sections. Remove the four rubber elements and separate the crankcase from the tank.

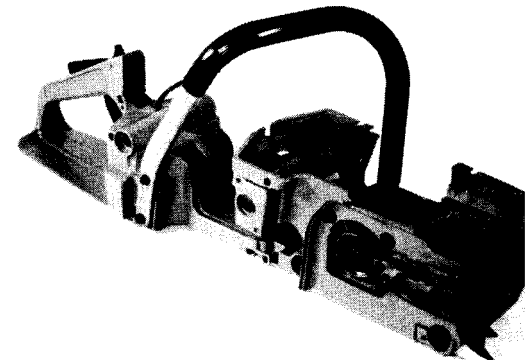

13

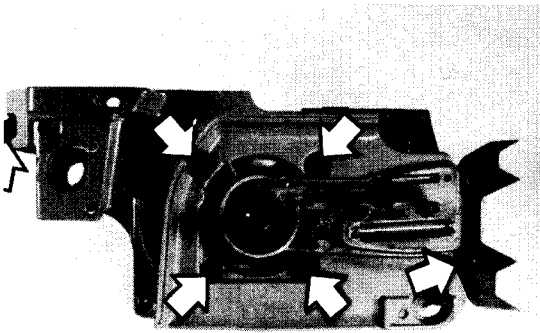

Remove the remaining six screws retaining the crankcase halves together.

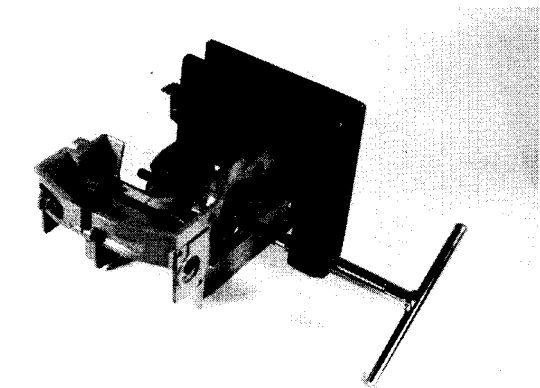

Mount tool P/N 5025161-01 on the clutch side of the crankshaft and crankcase. Separate the crankcase halves by pressing the crankshaft out of the right crankcase half.

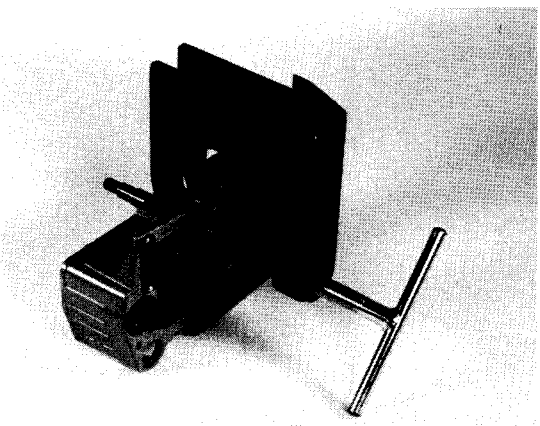

Mount the tool on the left crankcase half and press out the crankshaft.



Remove the crankshaft bearings from the crankcase halves by heating up the crankcase around the crankshaft bearing then pressing the bearing out of the case.

Checking the Crankshaft

The crankshaft is not serviceable and must be exchanged if defective. Some crankshafts may have a slight blue discoloration around the crank pin. This is a normal condition caused by the heat treatment around the crank pin hole during assembly.

Very carefully inspect the connecting rod big-end (crank pin) bearing. Hold the connecting rod flush against one crank half and then the other while rotating the rod around the pin. Look for cracks or other damage to the bearing cage. Examine the connecting rod big-end for seizure marks on the sides or discoloration.

Check for radial movement (up and down play) of the connecting rod. Replace the crankshaft if radial movement is detected. Slight axial movement (side-to-side) is acceptable.

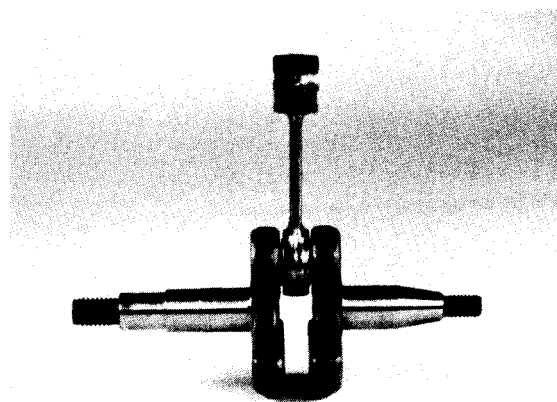
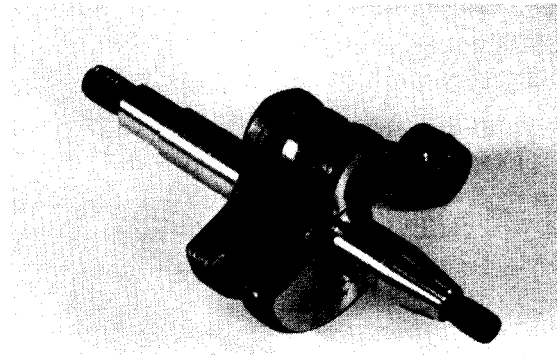

Check the small-end of the connecting rod. If seizure marks or discolored spots are evident in the bearing seat, the crankshaft must be replaced.

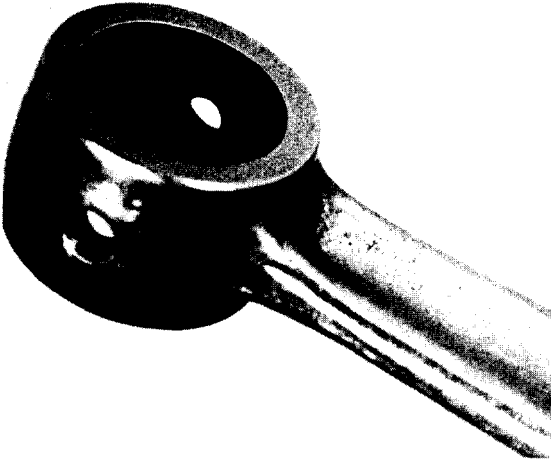

Assembly

Thoroughly clean all parts before assembly. Make sure the crankcase half mating surfaces are clean and free of all gasket material. Heat the bearing seat area of the ignition (right) side crankcase half and install the crankshaft bearing. Make sure the bearing is fully seated.

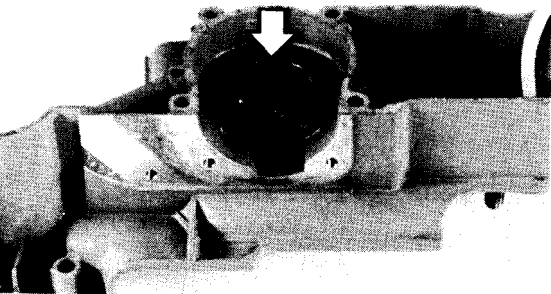

Heat the bearing seat area of the drive (left) side crankcase half and install the crankshaft bearing ensuring it is fully seated.

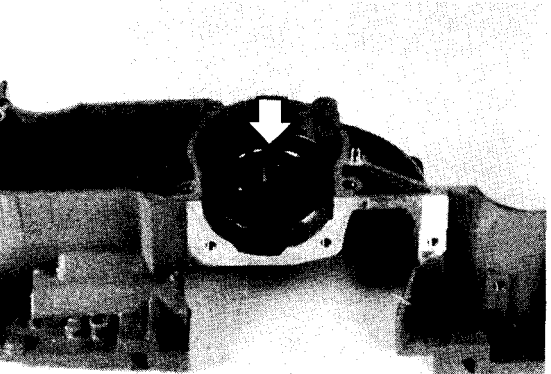

13

Using assembly tool P/N 5025030-10 pull the crankshaft into the ignition side crankcase half. Make sure the crankshaft is flush against the bearing.

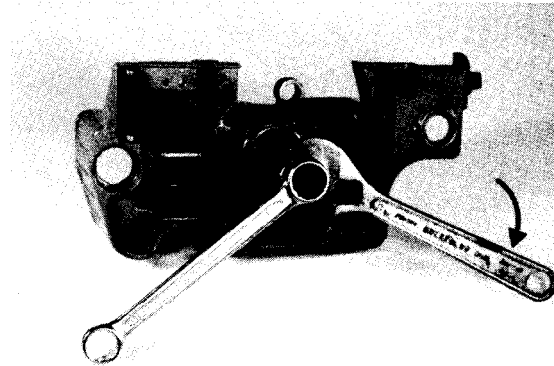

Position the crankcase gasket onto the ignition side crankcase half using a light coat of grease to hold it in place.

NOTE !

The crankcase alignment pins should be located in the ignition side crankcase half.

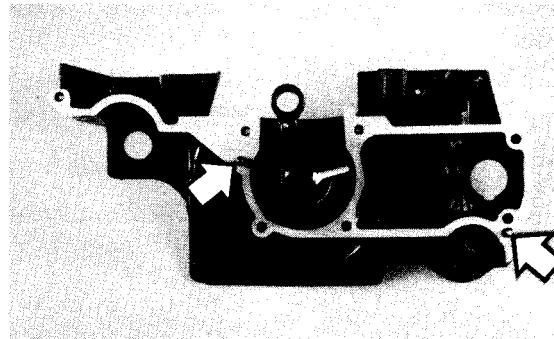

Slide the drive side crankcase half onto the crankshaft, then mount the assembly tool. Pull the crankshaft into the crankcase half while guiding the two halves together. If necessary, start a few crankcase screws to hold the gasket in place. Make sure the crankshaft is flush against the bearing, then remove the assembly tool.

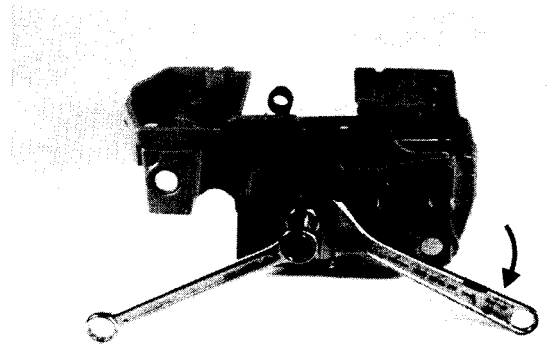

Install all the crankcase screws except the top front screw which also retains the bar spike and muffler support. Starting with the screws around the crankshaft, tighten all six screws to 7-9 Nm (5.1-6.6 ft.lbs.) torque.

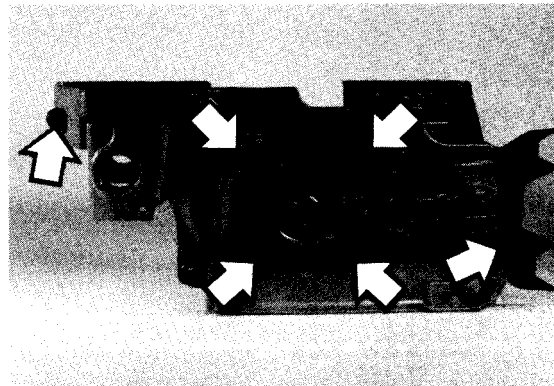

13

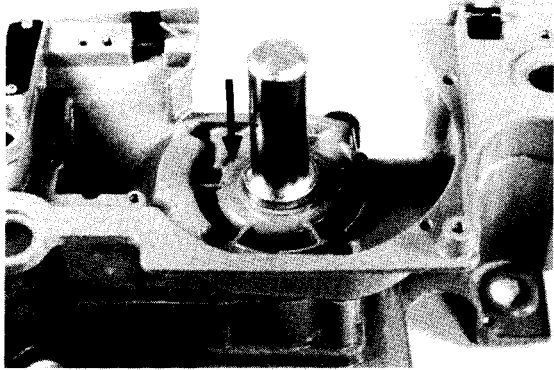

Always use new crankshaft seals. Begin with the ignition side. Apply grease to the crankshaft seal lip and carefully slide the seal over the end of the crankshaft. The open side of the seal must face inward. Drive the seal into the crankcase using tool P/N 5025079-01 until the seal is flush with the crankcase. Install the drive side crankshaft seal in the same manner.

The remainder of reassembly is the reverse of disassembly. Refer to the appropriate sections for reassembly instructions.